

LIMIX guided Incremental Linear Encoder
for elevator applications

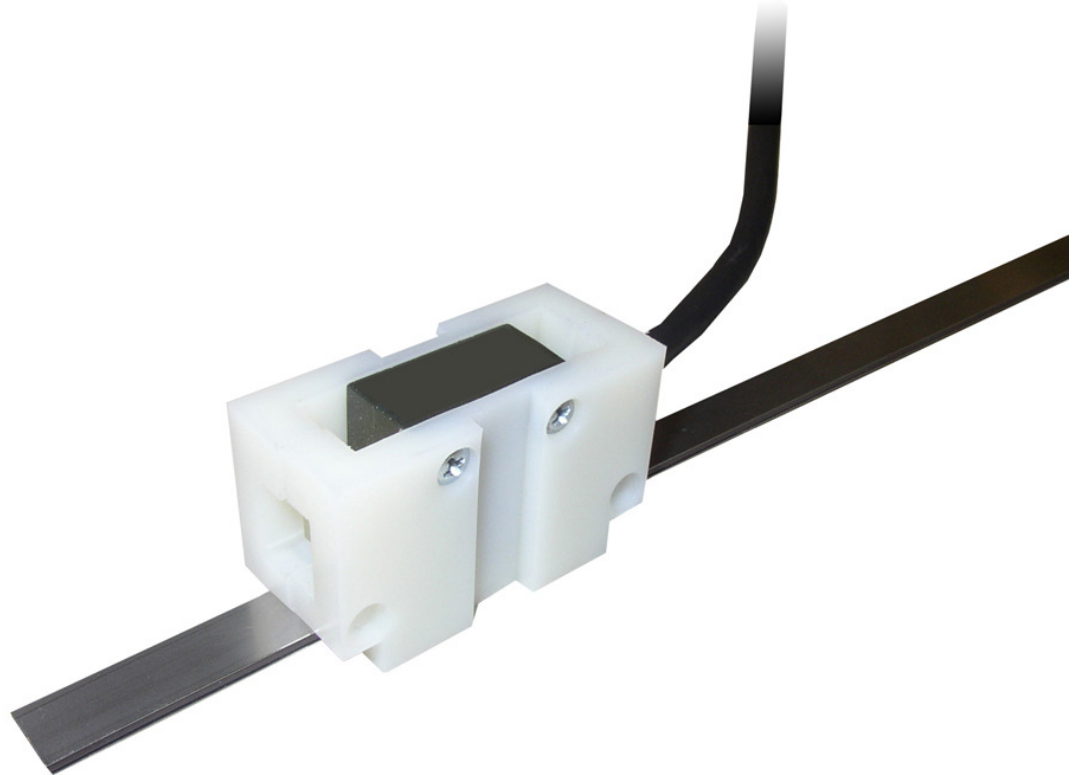

Only functional with an ELGO MB20-50-10-1-R-D magnetic tape!

- Mechanically guided Lift Encoder
- Direct measurement at the cabin
- Low noise and touchless measurement principle
- Insensitive sensor head (IP67)
- Easy to install
- No Jojo-effect
- Periodic index pulse output
- 0.625 / 1.25 or 2.5 mm resolution
(depends on multi edge counter)
- Repeat accuracy +/- increment
- Small sensor head with integrated translator
- Speed proportional square wave output

1. INTRODUCTION	3
2. THE SENSOR	3
2.1 Functionality of the sampling sensors	3
2.2 Resolution/Edge multiplier	3
2.3 Dimensions	3
2.4 Installation in an elevator shaft	4
3. SUPPLY AND OUTPUT VERSIONS	5
4. CONNECTORS OF LIMIX2	5
5. OUTPUT PULSE DIAGRAM	6
6. HINTS FOR INSTALLATION	6
6.1 Installation place	6
6.2 Supply voltage	6
6.3 Fault clearance	6
7. TECHNICAL SPECIFICATIONS	7
8. THE MAGNETIC TAPE MB20-50-10-1-R-D	8
8.1 Construction R-D (2 components)	8
8.2 Resistance against chemical influences	8
8.3 Technical specifications of the tape	9
8.4 Note for storage:	9
9. TYPE DESIGNATION	10
10. LIABILITY EXCLUSION / GUARANTEE	11

1. Introduction

The incremental LIMIX measuring system was conceived particularly for applications within the elevator range. The guided system, with a guidance body from slidable plastic, is simple to install, moves the scanning sensor optimally over the magnetic tape and provides with its closed lower surface permanently for the correct mounting distance between sensor and magnetic tape.

The plastic body consists of 2 identical halves. The sensor can be inserted and fastened by conventional M3 screws with its assembly drillings, which are corresponding to the mounting holes at the block halves. The installation of the complete LIMIX system can be made alternatively by the sensor drillings (with extended M3 screws) or by means of 2 additionally mounting holes, existing at the guidance block.

2. The Sensor

2.1 Functionality of the sampling sensors

Integrated in the sensor head are the magneto resistor measuring-bridges as well as the interpolation circuit and the output drivers. The bridge generates the distance dependent count pulses for the signal processing electronic. The sensor cable is an eight wire cable, highly flexible and suitable for tug chains. It consists of twisted pair wires and is shielded.

2.2 Resolution/Edge multiplier

The resolution of the system amounts to

- 2.5 mm at 1 x edge triggering
- 1.25 mm at 2 x edge triggering
- 0.625 mm at 4 x edge triggering

2.3 Dimensions

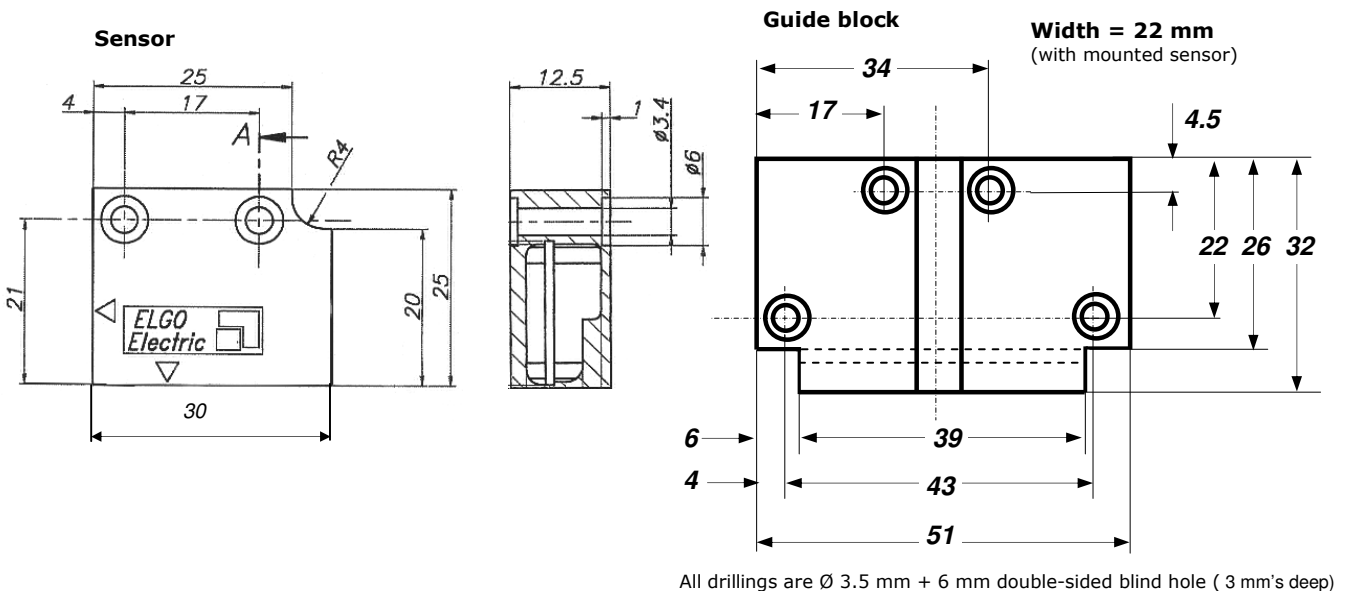

2.4 Installation in an elevator shaft

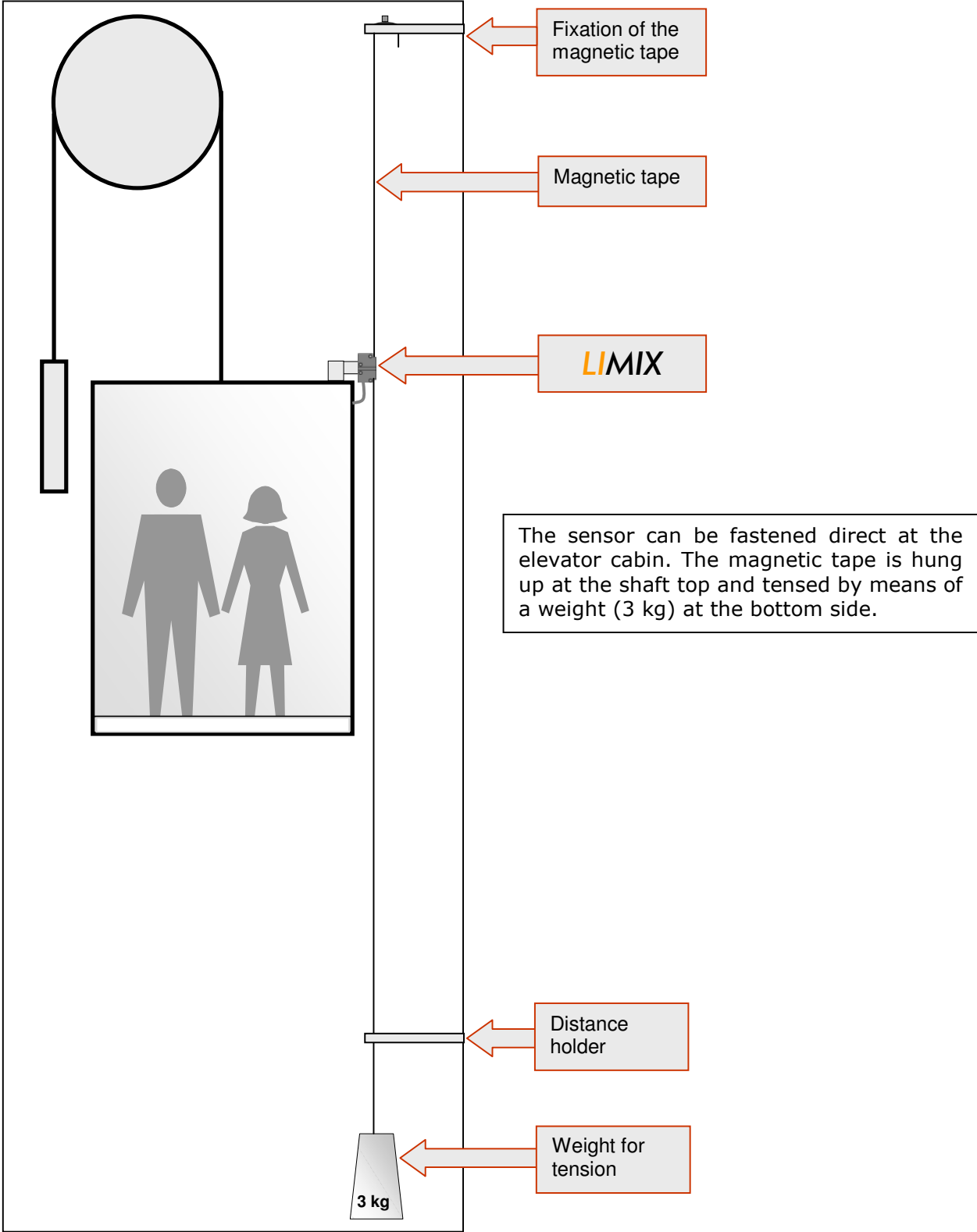

3. Supply and Output Versions

The following combination of supply and output levels are deliverable:

1. **Order index 00*** = supply voltage **10 - 30 V** / output level **10 - 30 V**
2. **Order index 01*** = supply voltage **10 - 30 V** / output level **TTL Line Driver**
3. **Order index 11*** = supply voltage **5 V** / output level **TTL Line Driver**

* **Order index** (see page 10 / point 9 type designation)

Note: To reach the largest possible interference distance it is recommended to supply the magnetic length system LIMIX2 with 10-30 VDC and to select the A/B signals TTL-compatible (5 V) (**Index 01**) and to evaluate them differential.

Voltage drop referring to wire length (only with supply voltage 5 VDC)

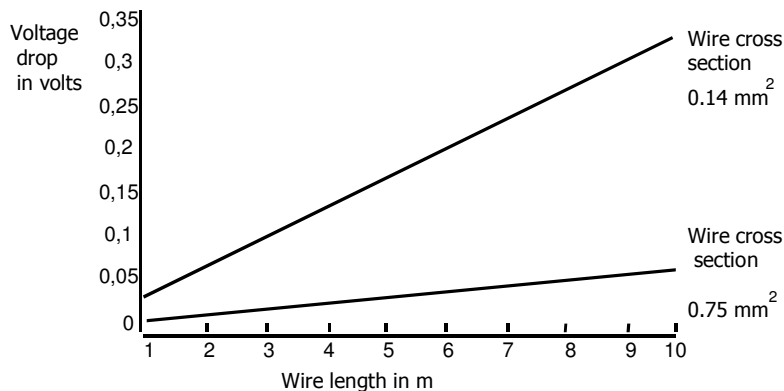

4. Connectors of LIMIX2

	Open wires Standard	9 pin D-SUB Option D1
Function	Color of wire	Pin No.
0V (GND)	white	1
5 VDC/10-30 VDC in	brown	2
Channel A	green	3
Channel B	yellow	4
Channel Z	black	8
Channel A'	violet	6
Channel B'	orange	7
Channel Z'	gray	9
Shielding	PE 	Connected to housing

5. Output pulse diagram

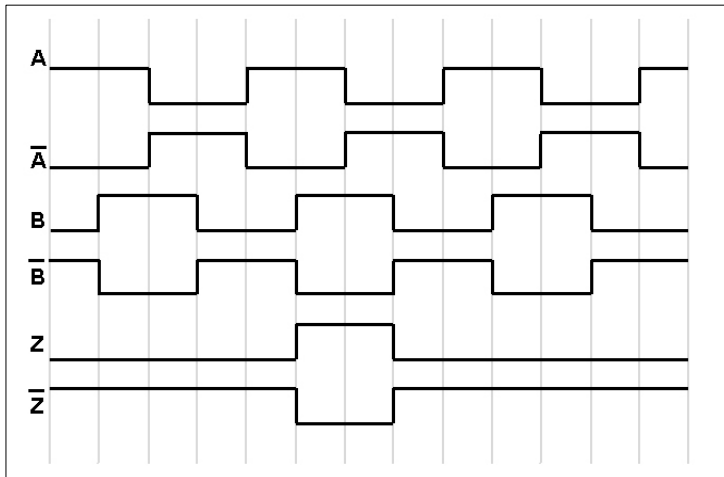

6. Hints for installation

6.1 Installation place

The installation place must be at least 0.5 m away from inductive and capacitive interference sources as contactors, relays, engines, switch power pack, clocked controllers, etc. The LIMIX2 cable must principally be wired separately from heavy duty current wires and a distance to interference sources must be kept.

6.2 Supply voltage

The supply voltages must be stabilized DC voltages and should not exceed 5 VDC with a tolerance of $\pm 2.5\%$. Allowed ripple at 10-30 VDC and 5 VDC is: < 50 mV.

6.3 Fault clearance

If there arise interferences in spite of observing all above mentioned points, proceed as follows:

1. Add RC elements over contactor reels of AC contactors (e.g. $0.1 \mu\text{F}/100 \Omega$).
2. Add recovery diodes over DC inductances
3. Add RC elements over each engine phase and over the engine brake

7. Technical specifications

Specification	LIMIX data
Mechanic	guided by a slidable plastic block
Principle of measurement	incremental
Signal processing (translator)	integrated in sensor head
Dimensions: sensor without guide block	L x W x H = 30 x 12.5 x 25 mm
Dimensions: sensor mounted with guide block	L x W x H = 51 x 22 x 32 mm
Resolution at 1 x edge triggering	2.5 mm
Resolution at 2 x edge triggering	1.25 mm
Resolution at 4 x edge triggering	0.625 mm
Repeat accuracy	+/- 1 increment
Accuracy in μm (20 °C)	+/- (25 + 20 x L) L = Measuring length in m
Distance to the tape	determined by the guide block
Sensor housing material	zinc die cast (black)
Guide block material	slideable PA6G oil
Protection class	IP67
Working temperature range	-10 ... + 70 °C (-25... +85 °C) auf Anfrage
Stock temperature range	- 25 ... + 85 °C
Humidity	max. 90 % not condensing
Operation height	max. 2000 m above sea level
Outputs	push / pull, durable short circuit proof
Output signal levels	10... 30 V-HTL or 5 V-TTL
Output currency per channel	20 mA
Index pulse	periodically, each 5 mm
Index pulse time	depends on operating speed
DC - power supply	10... 30 VDC +/- 10 % or 5 VDC +/- 2.5 %
Allowed ripple	max. 5 % at 10... 30 V resp. < 50 mV at 5 V
Consumption	150 mA at 10... 30 V resp. 200 mA at 5 V
Operation speed	max. 5 m/s (with 10-30 V-HTL at optimal evaluation)
max. measuring length	theoretically unlimited *)
max. wire length (signal cable)	5 V / 5 V-TTL = 10 m 10... 30 V / 10... 30 V = 30 m 10... 30 V / 5 V-TTL = 50 m
Magnetic tape (Accessories)	MB20-50-10-1-R -D
*) max. available length of the magnetic tape	600 m
Pole distance	5 mm

Further specifications of the tape, see on page 10 >>

8. The Magnetic Tape MB20-50-10-1-R-D

8.1 Construction R-D (2 components)

In the case of LIMIX applications, the magnetic tape is delivered as described here.
The tape must be hung up at the top of the elevator shaft and tensed by a weight (app. 3 kg) at the bottom side

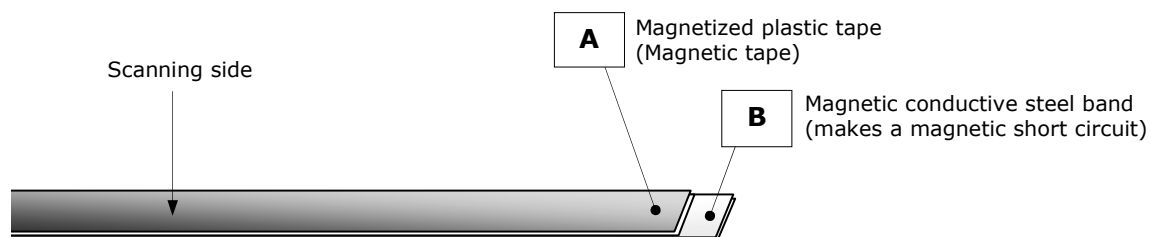

Thickness: **A + B** = 1.5 mm

Available lengths: See technical specifications

This deviating variant consist of 2 components

- A** The magnetized, highly flexible plastic tape, connected on the lower side with...
- C** ... a magnetic conductable and flexible stainless steel tape. It protects the plastic tape from mechanical damages and is a magnetic short circuit at the same time. This increases significantly the functional security under extreme magnetic influences. Both parts A and B are already factory-bonded.

8.2 Resistance against chemical influences

Chemicals, showing no or only small effects:			
formic acid	glycerol 93°C	linseed oil	soy beans oil
cotton seed oil	N-hexane	lactic acid	formaldehyde 40%
iso octane	petroleum		
Chemicals, showing small to medium effects:			
acetone	gasoline	acetic acid 30%	Olein acid
acetylene	steam	acetic acid, pure acetic acid	sea water
ammonia	acetic acid 20%	isopropyl ether	stearic acid 70°C
anhydrous	kerosene		
Chemicals, showing strong effects:			
benzene	nitric acid 70%	nitrobenzene	lacquer solvent
turpentine	nitric acid, red, vitriolic	carbon tetrachloride	trichloroethane
xylene	tetrahydrofuran	hydrochloric acid 37%, 93°C	

8.3 Technical specifications of the tape

Working temperature range	0°... + 70°C
Operating temperature range	- 20°... + 85°C
Stock temperature range	- 40°... + 95°C
Operation height	max. 2000 m above sea level
Humidity	max 80 % (not condensing)
Linear extension (relative) ΔL	$\Delta L = L \times \alpha \times \Delta \vartheta$ (L = Measuring length in meters) ($\Delta \vartheta$ = relative change of temperature in °K, based on 20° C room temperature)
Coefficient of extension α	$16 \times 10^{-6} 1/K$
Bending radius	minimum 150 mm
Protection class	IP67
Width	10 mm +/- 0.2 mm
Thickness	1.5 mm +/- 0.1 mm (tape construction R-D)
max. available length	600 m (roll ware)
Pole length	5 mm
Influence of external magnets	External magnetic fields must not exceed 64 mT (640 Oe; 52kA/m) at the surface of the magnetic tape. Higher values will damage or destroy the magnetic tape code. Magnetic fields > 1 mT at the measuring system has negative influences on the system's accuracy.

8.4 Note for storage:



Please note: In order to avoid tensions in the tape, it should be stored in stretched or rolled up condition - with the magnetized plastic tape resp. scanning side outward (see image).

Determination of pole length resp. number of tracks on already installed tapes:

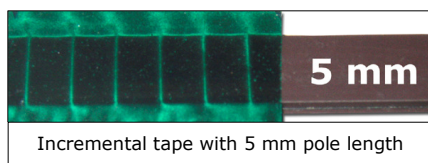

A special pole foil (app. 4 cm x 4 cm) is available as accessories and is useful to make the tape magnetization visible. The pole length or the number of absolute tracks can be determined, in order to replace an already installed or unknown tape correctly.

The pole foil can be ordered by using the following Article Number:
511000220

9. Type designation

LIMIX - XXX - XX,X - XXXX - XX - XXX

Series/Type _____

SN - Number _____

000 = standard

001 = first special variant

002... etc.

Cable length in XX,X m _____

Resolution (in μm at four times edge triggering)

0625 = 0.625 mm (resp. 2.5 mm at single edge triggering)

Power supply / Output levels _____

00 = 10-30 VDC / 10-30 VDC HTL

01 = 10-30 VDC / 5 V-TTL line driver

11 = 5VDC / 5V-TTL line driver

Optionen _____

D1 = 9 pin D-SUB connector instead of open wires

Magnetic tape (accessories)

MB20 - 50 -10 -1- R-D - XXX.X

ELGO Magnetic tape _____

Basic pole division _____

5.0 mm

Width _____

10 mm

Number of magnetic tracks _____

1 = Single track system (incremental)

Tape construction _____

R = Magnetic tape bonded on magnetic permeable steel tape

Options _____

D = Without cover band and sticky tape

Length _____

Please indicate the desired length in **XXX.X meters**

10. Liability exclusion / Guarantee

We have checked the contents of this instruction manual carefully, to the best of our knowledge and belief for conformity with the described hardware and software. Nevertheless errors, mistakes or deviations can not be excluded, therefore we do not guarantee complete conformity. Necessary corrections will be included in the subsequent editions. We appreciate your ideas and improvement suggestions very much. Reprint, duplication and translation, even in extracts, are only allowed with a written authorization by the company ELGO Electric GmbH. We constantly strive for improving our products, therefore we keep all rights reserved for any technical modifications without any notice.

ELGO Electric does not assume any liability for possible errors or mistakes.

The guarantee period is one calendar year from the date of delivery and includes the delivered unit with all components. ELGO Electric GmbH will at its option replace or repair without charge defects at the unit or the included parts, verifiable caused by faulty manufacturing and/or material in spite of proper handling and compliance to the instruction manual.

Damages verifiably not caused by ELGO Electric GmbH and due to improper handling are excluded from any guarantee e.g. by applying faulty voltage, diffusion of liquid into the interior of the engine, using force, scratching the surface, chemical influences etc.!

Subject to modifications - © ELGO Electronic GmbH & Co. KG 2006
LIMIX-000-E_05-06

ELGO Electronic GmbH & Co. KG
Measure - Control - Position
Carl - Benz - Straße 1, D-78239 Rielasingen
Fon: +49 (7731) 9339-0, Fax: +49 (7731) 28803
Internet: www.elgo.de. Mail: info@elgo.de

