

CANopen Specifications

LIMAX Safe SG/SC

Protocol description of the CANopen interface

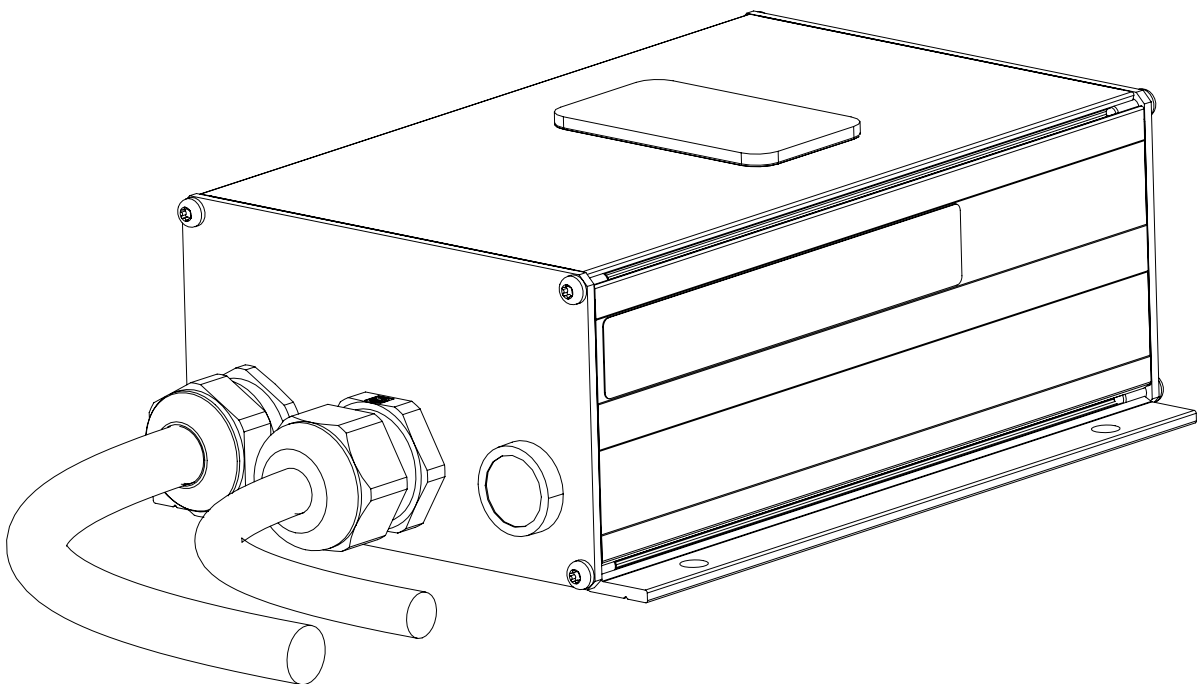

- Manufacturer specific extensions additionally to the DS406 profile

Publisher ELGO Batscale AG
Föhrenweg 20
FL-9496 Balzers

Technical Support ☎ +49 (0) 7731 9339 – 0
☎ +49 (0) 7731 2 13 11
✉ support@elgo.de

Document- No. D-100968

Document - Name LIMAXSAFE-006-CANopen-E_12-15

Article Number 799000964

Document- Revision Rev. 3

Issue Date 2015-03-18

Copyright © 2015, ELGO Batscale AG

1 Contents

1	Contents.....	3
2	General.....	5
2.1	Normative references	5
2.2	Terms and abbreviations	5
2.3	Conventions.....	5
3	System overview	6
4	Object dictionary	6
4.1	Object 2100h: I/O state and mode register	6
4.2	Object 210Fh: Device information.....	7
4.3	Object 2110h: Door zone size	8
4.4	Object 2111h: Limit switches and limit switch indicator position offsets	10
4.5	Object 2112h: NOC test parameter	11
4.6	Object 2120h: Over-bridging door contact	12
4.7	Object 2121h: Over-bridging door contact (16 bit access).....	13
4.8	Object 2124h: Temporary Reference positions for limit switches	13
4.9	Object 2128h: Relay test	15
4.10	Object 2129h: OC test	16
4.11	Object 212Ah: Direct Relay Access.....	18
4.12	Object 212Fh: Safe Box special functions	19
4.13	Object 2140h: Floor table	19
4.14	Object 2148h: Floor table of the control	21
4.15	Object 2150h: Fault register	23
4.16	Object 2158h: Defect log channel B.....	25
4.17	Object 2159h: Defect log channel A	31
4.18	Object 215Ch: Sensor error registers	31
4.19	Object 215Dh: Sensor statistics.....	31
4.20	Object 21E0h: Rated Speed / (pre-)tripping speed	32
4.21	Object 21E1h: Brake Type	33
5	Communication objects	34
5.1	Transmit PDOs	34
5.2	Receive PDOs	39
6	Error handling	43
6.1	Error appearance.....	43
6.2	Error clearing	43
6.3	Object 1001h: Error register.....	43
6.4	Emergency error codes	43
A	Object dictionary overview.....	44
B	Communication sequence examples	46

B.1	Start-up.....	46
B.2	Teach procedure	47
B.3	Door over-bridging communication	48
B.4	Relay test communication.....	49
C	Distance relations.....	50
D	CANopen keywords.....	51
E	CANopen basics	52
E.1	Contents	52
E.2	Initial Operation	52
E.3	Command Descriptions	52

2 General

2.1 Normative references

/CiA301/	CiA 301, CANopen application layer and communication profile
/CiA406/	CiA 406, Device profile for encoders

2.2 Terms and abbreviations

Abbreviation/ Term	Explanation
CAN	Controller Area Network
CiA	CAN in Automation
COB	Communication Object
CRC	Cyclic Redundancy Check
DIP	Dual Inline Package (electronic device package)
COB-ID	COB Identifier
LSB	Least Significant Bit
MSB	Most Significant Bit
NMT	Network Management
PDO	Process Data Object
ROM	Read Only Memory
RPDO	Receive PDO
SDO	Service Data Object
SIL	Safety Integrity Level
TPDO	Transmit PDO
UCM	Unintended Car Movement

2.3 Conventions

Unless otherwise stated, all numbers and values should be interpreted as decimal.

3 System overview

LIMAX Safe SG/SC consists of two units: Safe Box and sensor head. The system is connected with the lift control through a CANopen interface. The default node-ID of LIMAX Safe SG/SC is 4.

Fig. 1 shows the system architecture.

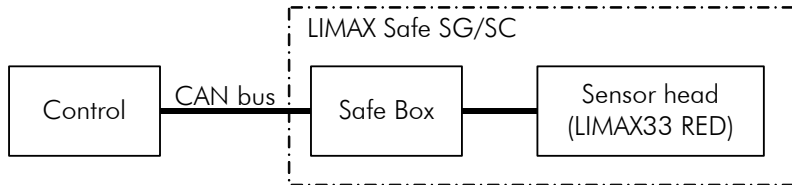

Fig. 1: System architecture

The device acts as an absolute linear encoder according to /CiA406/.

4 Object dictionary

All objects, which are needed to implement the safe functionality, are located in the manufacturer specific area (2000h range) in the object dictionary.

In order to achieve compatibility with other CANopen specifications the first sub-index from objects with multiple indices always shows the last sub-index, even it is constant.

The objects are divided into groups with a similar index, corresponding to their functional purpose:

- Index 210xh: Information from LIMAX Safe SG/SC to the control
- Index 211xh: Distance parameters
- Index 212xh: LIMAX Safe SG/SC function control (Over-bridging and relay test)
- Index 214xh: Floor table
- Index 215xh: Fault and error management, statistical data

Note: only manufacturer specific objects are described in this section. See /CiA301/ and /CiA406/ for further information on standard and device profile specific objects.

For a full list of implemented objects, see annex A.

4.1 Object 2100h: I/O state and mode register

This object represents the state of the (safety) inputs and (safety) outputs. Additionally two bits in this register are used to determine the device mode.

This object is mapped to TPDO 1 by default.

VALUE DEFINITION

Table 1: Structure of the I/O state register

Bit	Signal	Meaning
0	I_MI	Input maintenance state
1	I_TEACH	Teach button state
2	I_RESET	Reset input state
3	O_DZI	Door zone indicator state
4	O_OC	Over-bridgeable contact state
5	O_SGC	Safety gear / speed governor contact state
6	O_NOC	Non-over-bridgeable contact state
7	I_DCS	Door contact state

Bit	Signal	Meaning
8	I_UP	Input maintenance up
9	I_DOWN	Input maintenance down
10	I_SGC_FB	Input safety gear / speed governor feedback
11	OVBR_ACTIVE	Door over-bridge active flag
12	DEFECTS	Active Defects
13	FAULTS	Active Faults
14 – 15	MODE	Mode (see below)

The device mode is coded in the two most significant bits of the I/O state and mode register:

Table 2: Mode value

Value	Mode
0	Pre-commissioning mode
1	Teach mode
2	Adjustment mode
3	Normal mode

OBJECT DESCRIPTION

Index	2100h
Name	I/O State register
Object code	VAR
Data type	UNSIGNED16

ENTRY DESCRIPTION

Sub-index	00h
Access	ro
PDO mapping	TPDO, mapped to TPDO 1 by default
Value range	See <i>value definition</i>
Default value	no

4.2 Object 210Fh: Device information

Usually a device has only one single serial number and one single software version and therefore /CiA301/ does not provide a possibility to map the composition of LIMAX Safe SG/SC, where two devices with separate serial number and software version are used. To allow reading out the device information from the sensor object 210Fh was introduced.

This object includes the firmware CRC to verify the software version of sensor and Safe Box and the serial number of the sensor.

VALUE DEFINITION

- Sub-index 0 contains the highest sub-index in this object.
- Sub-index 1 contains the ROM-CRC of the Safe Box
- Sub-index 2 contains the ROM-CRC of the sensor head
- Sub-index 3 contains the serial number of the sensor head

The serial number of the safe box is readable in object 1018h sub-index 4.

OBJECT DESCRIPTION

Index	210Fh
Name	Device information
Object code	ARRAY
Data type	UNSIGNED32

ENTRY DESCRIPTION

Sub-index	00h
Description	Highest sub-index supported
Access	ro
PDO mapping	no
Value range	3
Default value	3

Sub-index	01h
Description	ROM-CRC of the Safe Box
Access	ro
PDO mapping	no
Value range	UNSIGNED32

Sub-index	02h
Description	ROM-CRC of the sensor
Access	ro
PDO mapping	no
Value range	UNSIGNED32

Sub-index	03h
Description	Serial number of the sensor
Access	ro
PDO mapping	no
Value range	UNSIGNED32

4.3 Object 2110h: Door zone size

This object contains the door zone sizes to pre-opening and re-levelling.

The door zone size can only be modified when LIMAX Safe SG/SC is in standstill. If the car is moving during a download request, LIMAX Safe SG/SC responds with the SDO abort transfer service (abort code: 0601 0000h – Unsupported access to an object).

VALUE DEFINITION

The value represents the distance from floor level to the upper limit of the door zone. The door zone is symmetrical relative to the floor level and therefore the value represents also the distance between the lower limit of the door zone and the floor level.

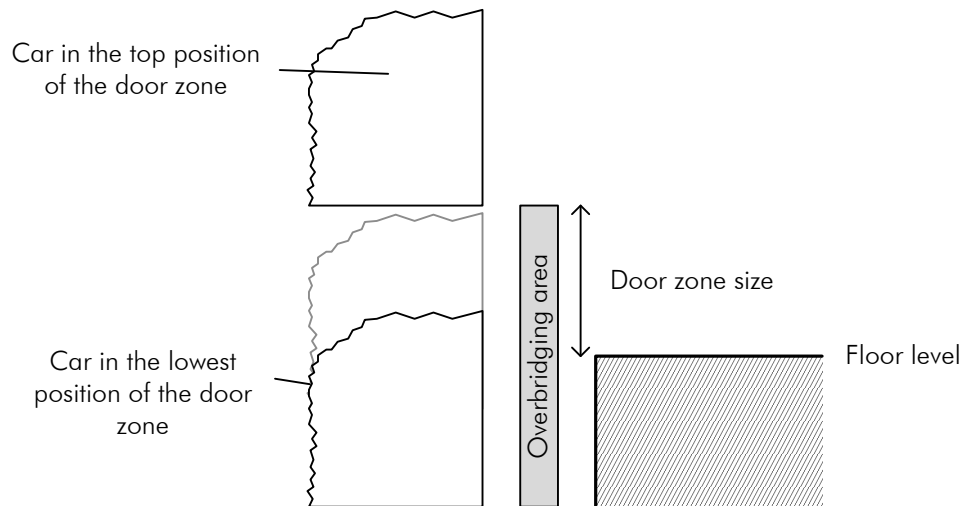

Fig. 2: Door zone size

The value of the pre-opening zone size (sub-index 01h) is given in multiples of 1 mm.
 The value of the re-levelling zone size (sub-index 02h) is given in multiples of 1 mm.

OBJECT DESCRIPTION

Index	2110h
Name	Door zone sizes
Object code	VAR
Data type	UNSIGNED16

ENTRY DESCRIPTION

Sub-index	00h
Description	Highest sub-index supported
Access	ro
PDO mapping	no
Value range	02h
Default value	02h

Sub-index	01h
Description	Door zone size for levelling (pre-opening)
Access	rw
PDO mapping	no
Value range	20 to 350
Default value	200

Sub-index	02h
Description	Door zone size for re-levelling (adjustment)
Access	rw
PDO mapping	no
Value range	20 to 200
Default value	140

4.4 Object 2111h: Limit switches and limit switch indicator position offsets

Limit switch offset values can only be modified when LIMAX Safe SG/SC is in standstill. If the car is moving during a download request, LIMAX Safe SG/SC responds with the SDO abort transfer service (abort code: 0601 0000h – Unsupported access to an object).

See Annex C for distance relations between floor positions and limit switches.

Sub-indices 0 to 4 contain the position offsets of the top and bottom shaft end limit switches.

Sub-indices 5 and 6 are reserved for future use (EN81-21) and are not implemented yet. In case a read/write access is performed to these sub-indices, LIMAX Safe SG/SC responds with the SDO abort transfer service (abort code: 0609 0011h – Sub-index does not exist).

Sub-index 7 contains the offset for the limit switch indicator LED and buzzer. The value specifies at which distance before the limit switch position the indicator and the buzzer should be turned on in maintenance.

VALUE DEFINITION

The values for the offsets (sub-indices 01h to 04h and 07h) are given in multiples of 1 mm.

OBJECT DESCRIPTION

Index	2111h
Name	Limit switches position offset
Object code	VAR
Data type	UNSIGNED16

ENTRY DESCRIPTION

Sub-index	00h
Description	Highest sub-index supported
Access	ro
PDO mapping	no
Value range	07h
Default value	07h

Sub-index	01h
Description	Top limit switch position offset in normal mode
Access	rw
PDO mapping	no
Value range	30 to 100
Default value	50

Sub-index	02h
Description	Top limit switch position offset in maintenance mode
Access	rw
PDO mapping	no
Value range	1300 to 2500
Default value	1300

Sub-index	03h
Description	Bottom limit switch position offset in normal mode
Access	rw
PDO mapping	no
Value range	30 to 100
Default value	50

Sub-index	04h
Description	Bottom limit switch position offset in maintenance mode
Access	rw
PDO mapping	no
Value range	1700 to 2500
Default value	1700

Sub-index	07h
Description	Limit switch indicator position offset
Access	rw
PDO mapping	no
Value range	100 to 4000
Default value	2000

4.5 Object 2112h: NOC test parameter

Object 2112h contains the adjustable parameters for the NOC test.

VALUE DEFINITION

- The value for the stand still tolerance (sub-index 01h) is given in multiples of 1 mm.
- The value for the oscillation time tolerance (sub-index 02h) is given in multiples of 10 ms.
- The value for the motor brake delay time (sub-index 03h) is given in multiples of 10 ms.
- The value for the motor brake deceleration (sub-index 04h) is given in multiples of 1 mm/s².

OBJECT DESCRIPTION

Index	2112h
Name	NOC test parameter
Object code	VAR
Data type	UNSIGNED16

ENTRY DESCRIPTION

Sub-index	00h
Description	Highest sub-index supported
Access	ro
PDO mapping	no
Value range	04h
Default value	04h

Sub-index	01h
Description	Stand still tolerance
Access	rw
PDO mapping	no
Value range	1 to 50
Default value	10 (= 10 mm)

Sub-index	02h
Description	Time tolerance for oscillation
Access	rw
PDO mapping	no
Value range	20 to 200
Default value	100 (= 1000 ms)

Sub-index	03h
Description	Time delay for motor brake
Access	rw
PDO mapping	no
Value range	20 to 100
Default value	50 (= 500 ms)

Sub-index	04h
Description	deceleration of motor brake
Access	rw
PDO mapping	no
Value range	1000 to 2000
Default value	1700 (= 1.7 m/s ²)

4.6 Object 2120h: Over-bridging door contact

This object controls the over-bridging of the door contact in the safety circuit. See door over-bridge example (B.3) for a detailed usage of this object.

To enable door over-bridging the appropriate floor number must be sent with the enable command.

To disable door over-bridging bit 0 and 1 must be cleared. The floor number does not have to fit with the previous enable command. In other words, over-bridging is disabled, when both flags are cleared, regardless of the floor number.

This object is mapped to RPDO 1 by default.

VALUE DEFINITION

Table 3: Structure of the over-bridging door safety register

Bit	Value	Meaning
0 (OB_LEV)	0b	Don't over-bridge door contact when leveling (pre-opening)
	1b	Over-bridge door contact when levelling
1 (OB_ADJ)	0b	Don't over-bridge door contact when re-levelling (adjusting)
	1b	Over-bridge door contact when re-levelling
2 to 7	1-32	Identifies the floor for which door-over-bridging has to be activated.

OBJECT DESCRIPTION

Index	2120h
Name	Overbridging door contact
Object code	VAR
Data type	UNSIGNED8

ENTRY DESCRIPTION

Sub-index	00h
Access	wo
PDO mapping	RPDO, mapped to RPDO 1 by default
Value range	See <i>value definition</i>
Default value	00h

4.7 Object 2121h: Over-bridging door contact (16 bit access)

This object has the same function as the previous object. With this object it's possible to address more than 63 floors.

To enable door over-bridging the appropriate floor number must be sent with the enable command.

To disable door over-bridging bit 0 and 1 must be cleared. The floor number does not have to fit with the previous enable command. In other words, over-bridging is disabled, when both flags are cleared, regardless of the floor number.

This object is not mapped to any PDO per default.

VALUE DEFINITION

Table 4: Structure of the over-bridging door safety register

Bit	Value	Meaning
0 (OB_LEV)	0b	Don't over-bridge door contact when leveling (pre-opening)
	1b	Over-bridge door contact when levelling
1 (OB_ADJ)	0b	Don't over-bridge door contact when re-levelling (adjusting)
	1b	Over-bridge door contact when re-levelling
2 to 4	0	Reserved
8 to 15	1-255	Identifies the floor for which door-over-bridging has to be activated.

OBJECT DESCRIPTION

Index	2121h
Name	Overbridging door contact
Object code	VAR
Data type	UNSIGNED16

ENTRY DESCRIPTION

Sub-index	00h
Access	wo
PDO mapping	no
Value range	See <i>value definition</i>
Default value	00h

4.8 Object 2124h: Temporary Reference positions for limit switches

In this object the upper and lower temporary reference positions to calculate the limit switch positions are stored. These positions are used to calculate the position of temporary final limit switches and temporary maintenance limit switches in teach mode, when no valid shaft image exists.

Teaching temporary reference positions

In order to store a temporary reference positions in RAM (volatile) the control must send the keyword "SETL" (see Fig. 4) to the appropriate sub-index.

Teaching of temporary reference positions is only accepted in teach mode and only in standstill. If one of these conditions does not meet, LIMAX Safe SG/SC responds with the SDO abort transfer service (abort code: 0601 0000h – Unsupported access to an object.).

If the lower temporary reference position already is set, teaching of the upper temporary reference positions in not accepted on a position lower than lower temporary reference position. In this case LIMAX Safe SG/SC responds with the SDO abort transfer service, abort code: 0609 0032h – Value of parameter written too low).

If the upper temporary reference position already is set, teaching of the lower temporary reference positions is not accepted on a position higher than upper temporary reference position. In this case LIMAX Safe SG/SC responds with the SDO abort transfer service (abort code: 0609 0031h – Value of parameter written too high).

If the temporary reference position with the current sub-index is already taught, its position would be overwritten with the actual position value.

Non volatile storing of temporary reference positions

Both temporary reference positions are stored non volatile under the following conditions:

- The upper temporary reference position is currently taught and the lower temporary reference position is set (already exists)
- The lower temporary reference position is currently taught and the upper temporary reference position is set (already exists)

Erasing of temporary reference positions

Both temporary reference positions are erased if teach mode is left by use of the teach button, but they are not erased if teach mode is left due to 15 minutes in standstill elapsed.

Reading of temporary reference positions

Reading of sub-index 1 will return the temporary bottom reference position. If the temporary bottom reference position is not set, LIMAX Safe SG/SC responds with the SDO abort transfer service (abort code: 0800 0024h – No data available).

Reading of sub-index 2 will return the temporary top reference position. If the temporary top reference position is not set, LIMAX Safe SG/SC responds with the SDO abort transfer service (abort code: 0800 0024h – No data available).

Sub-index 1 contains the bottom reference position.

Sub-index 2 contains the top reference position.

VALUE DEFINITION

The values for the positions (sub-indices 01h to 02h) are given in multiples of 1 mm. See Fig. 3 for details about the structure.

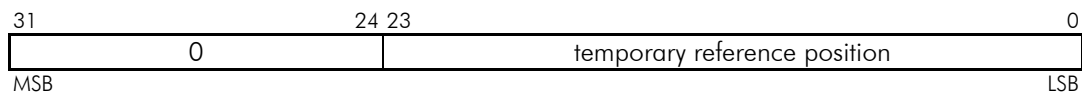

Fig. 3: Temporary reference position object entry

In order to store a temporary reference positions in RAM (volatile) the control must send the keyword "SETL" (see Fig. 4) to the appropriate sub-index.

	L	T	E	S
MSB	4Ch	54h	45h	53h
				LSB

Fig. 4: Set temporary reference position keyword

OBJECT DESCRIPTION

Index	2124h
Name	Temporary reference positions for limit switches
Object code	VAR
Data type	UNSIGNED32

ENTRY DESCRIPTION

Sub-index	00h
Description	Highest sub-index supported
Access	ro
PDO mapping	no
Value range	02h
Default value	02h

Sub-index	01h
Description	Temporary bottom reference position
Access	rw
PDO mapping	no
Value range	See <i>value definition</i>
Default value	No

Sub-index	02h
Description	Temporary top reference position
Access	rw
PDO mapping	no
Value range	See <i>value definition</i>
Default value	No

4.9 Object 2128h: Relay test

The safety gear / speed governor relay must be checked periodically for proper relay function to ensure it works well in case of emergency. This object is used to do a handshaking with the control before LIMAX Safe SG/SC does this test. This avoids that SGC will be opened while the car is moving.

The handshaking is done by exchange some keywords between LIMAX Safe SG/SC and the control. See relay test communication example (B.4) for a detailed usage of this object.

This object is mapped to TPDO 3 and RPDO 3 by default.

VALUE DEFINITION

Table 5: Structure of the relay test register

Value	Meaning
55h	LIMAX Safe SG/SC sends this value to the control when it wants to do a relay test
A5h	With this value the control gives LIMAX Safe SG/SC clearance to perform the relay test. The control has to ensure the car is in standstill before sending this message to avoid activation of the safety gear.
AAh	LIMAX Safe SG/SC sends this value to the control after it has finished the relay test. The control is now allowed to continue with normal operation. This is the default value read from this object (by SDO) when no relay test is pending or in operation.

When the control wants to write any other value than A5h to this object, LIMAX Safe SG/SC will respond with the SDO abort transfer service (abort code: 0609 0030h – Invalid value for parameter).

OBJECT DESCRIPTION

Index	2128h
Name	Relay test
Object code	VAR
Data type	UNSIGNED8

ENTRY DESCRIPTION

Sub-index	00h
Access	rw
PDO mapping	Yes, mapped to TPDO 3 and RPDO 3 by default
Value range	See <i>value definition</i>
Default value	AAh

4.10 Object 2129h: OC test

With this object LIMAX Safe SG/SC is able to check if the OC is bridged externally.

There are two kinds of check implemented:

- Explicit check: OC is opened in order to check if door input changes from closed to open
- Implicit check: whenever OC opens it is checked if door input is open. But there are exceptions from this rule (refer below).

To use this function it must be enabled through object 212Fh sub-index 65.

This object is not mapped to any PDO per default.

VALUE DEFINITION

The high byte of the 16-Bit contact test register is responsible for the explicit test, the low byte for the implicit test.

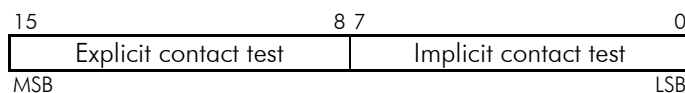

Fig. 5: OC test register

Explicit contact test (high byte)

There are prerequisites in order to enable LIMAX Safe SG/SC to carry out an explicit test: OC must be closed, door input must be closed, and lift must be in standstill. Whenever all these prerequisites are fulfilled, lift control may set bit 7 of the high byte (bit 15 of the register) in order to start the test. If not all prerequisites are fulfilled, bit 5 of the high byte of contact test register is set. If this is done by SDO, LIMAX Safe SG/SC answers with SDO abort transfer service (abort code: 0601 0000h – Unsupported access to an object). The same applies if a test is already running.

If 24 h since last test have been elapsed, LIMAX Safe SG/SC sets bit 5 of the high byte in order to remember control that it is time to do the test.

If 25 h since last test have been elapsed, LIMAX Safe SG/SC will start the test by itself as soon as all prerequisites are fulfilled. In this case LIMAX Safe SG/SC will set high byte bit 7 by itself. In any case LIMAX Safe SG/SC will clear bit 7 as soon as test is ready. Only LIMAX Safe SG/SC can clear bit 7 of the high byte.

If more than 25 h are elapsed without prerequisites being fulfilled, LIMAX Safe SG/SC will open OC and set bit 4 of the high byte.

The test fails if door input stays closed when OC opens. In this case LIMAX Safe SG/SC will set an error and additionally bit 6 of the high byte is set for information.

Table 6: Structure of the contact test register high byte (explicit contact test)

Bit	Bit of high byte	Meaning at write access	Meaning at read access
15	7	1 = command to start contact test 0 = otherwise	1 = contact test running 0 = otherwise
14	6	not used	1 = contact test finished fail (shortcut detected) 0 = otherwise
12	5	not used	1 = demand for contact test refused *) 0 = otherwise
13	4	not used	1 = OC open due to overdue contact test 0 = otherwise
11	3	not used	1 = remember control: more than 24h since last contact test elapsed (No prerequisite for contact test, just for information) 0 = less than 24h since last contact test elapsed
10	2	not used	1 = lift in standstill (prerequisite for contact test) 0 = lift moves
9	1	not used	1 = door input closed (prerequisite for contact test) 0 = door input open
8	0	not used	1 = OC closed (prerequisite for contact test) 0 = OC open

*) This bit is set if not all prerequisites (bits 0 ... 2) for contact test are fulfilled at the moment when LIMAX Safe SG/SC receives the command to do the contact test. The control should check the prerequisites (Bit 0 = 1, bit 1 = 1, bit 2 = 1), so it should normally work. But in some expectation cases a door contact may open in the short time between check in the control and the start of contact test in LIMAX Safe SG/SC. This bit is for information about exceptions like this. On SDO-side this would correspond with an abort transfer.

Implicit contact test (low byte)

If the implicit test fails (door input closed although FIHB open) LIMAX Safe SG/SC will set bit 1 of the contact test register.

Implicit test is not performed in inspection. Therefore the register contains inspection information on bit 5.

Lift control may set LIMAX Safe SG/SC to recall state bit setting bit 7. But this is not accepted in inspection mode. The trial to set bit 7 in inspection will be refused by the abort transfer service (abort code: 0601 0000h – Unsupported access to an object), and bit 6 will bit set so that there is also information in case of PDO.

Writing 0 to bit 7 by CANopen will terminate recall state, if lift is switched to inspection, LIMAX Safe SG/SC will write 0 to bit 7 and terminate recall state by itself.

In case of recall state LIMAX Safe SG/SC will supervise on recall over speed. If the car travels faster than recall over speed threshold NOC opens and LIMAX Safe SG/SC sets bit 4. LIMAX Safe SG/SC closes NOC and clears bit 4 after 10 s in standstill.

Table 7: Structure of the contact test register low byte (implicit contact test)

Bit	Meaning at write access	Meaning at read access
7	1 = command to go to recall state 0 = command to terminate recall state	1 = LIMAX Safe SG/SC is in recall state 0 = otherwise
6	not used	1 = demand for recall state refused due to inspection (resp. recall state left due to inspection has been entered) 0 = otherwise
5	not used	1 = in inspection 0 = otherwise
4	not used	1 = NOC open due to recall over-speed 0 = otherwise
3	Reserved	Reserve

Bit	Meaning at write access	Meaning at read access
2	Reserved	Reserve
1	not used	1 = error has been set due to implicit contact test fail 0 = otherwise
0	not used	1 = FIHB open 0 = otherwise

OBJECT DESCRIPTION

Index	2129h
Name	Contact test
Object code	VAR
Data type	UNSIGNED16

ENTRY DESCRIPTION

Sub-index	00h
Access	rw
PDO mapping	TPDO or RPDO
Value range	0 to 63
Default value	0

4.11 Object 212Ah: Direct Relay Access

Object 212Ah can be used to open the relays unconditionally, for example for energy saving purposes. The register is 8 bit width, but only bit 0 to 2 are used. Writing the value 1 to bit 0, bit 1, or bit 2 will opens the OC, NOC or SGC relay unconditionally.

VALUE DEFINITION

Table 8: Structure of the relay direct access register

Bit	Meaning
3 ... 7	Reserved
2	1 = SGC always open 0 = SGC follows the "normal conditions" as known
1	1 = NOC always open 0 = NOC follows the "normal conditions" as known
0	1 = OC always open 0 = OC follows the "normal conditions" as known

OBJECT DESCRIPTION

Index	212Ah
Name	Direct relay access
Object code	VAR
Data type	UNSIGNED8

ENTRY DESCRIPTION

Sub-index	00h
Access	rw
PDO mapping	No
Value range	See value definition
Default value	0h

4.12 Object 212Fh: Safe Box special functions

This object is used to enable optional special functions. Currently only the OC test function can be enabled. See operating manual for further details about this function.

OC test

The OC test is an optional function that may be enabled to test the external wiring. See object 2129h for further details.

This object is not mapped to any PDO per default.

VALUE DEFINITION

Table 9: Structure of the OC test enable register

Value	Meaning
0	Do nothing. Once contact test is enabled, it may not be disabled again.
1 ... 254	Reserved
255	Enable contact test

OBJECT DESCRIPTION

Index	212Fh
Name	Safe Box special functions
Object code	VAR
Data type	UNSIGNED8

ENTRY DESCRIPTION

Sub-index	00h
Description	Highest sub-index supported
Access	ro
PDO mapping	no
Value range	41h
Default value	41h

Sub-index	41h
Description	OC test enable register
Access	rw
PDO mapping	no
Value range	0 or 255
Default value	0

4.13 Object 2140h: Floor table

In this object the floor table is stored.

Teaching floor levels

In order to store a floor in the temporary floor table in RAM the control must send the keyword "SETF" (see Fig. 7) to the appropriate sub-index.

If the floor with the current sub-index is already taught, its level would be overwritten with the actual value.

Teaching floors can only be done when LIMAX Safe SG/SC is in standstill and doors are open. If the car is moving during a download request or doors are closed, LIMAX Safe SG/SC responds with the SDO abort transfer service (abort code: 0601 0000h – Unsupported access to an object).

Store floor table and leave the teach mode

It does not depend in what order the floors are learned, but the positions must be increasing with respect to increasing sub-indices.

To transfer the floor table into the EEPROM, leave the teaching mode, by use of the teach button.

For a successful store process all of the following criteria must be met:

- There must not be any gaps between floor numbers
- All floor positions must be in ascending order with respect to increasing sub-indices.

If at least one of these criteria is not met, LIMAX Safe SG/SC will refuse to store its floor image into the EEPROM.

When the teach mode is once left, this object cannot be modified anymore without re-entering teach mode again, which in turn erases the whole floor table.

Adjust floor levels

When minor changes happen to the building, it is possible to adjust the floor levels between ±50 mm.

To do so, the car has to be brought in the right position and then the control has to send the adjust keyword “ADJF” (see Fig. 8) to the appropriate sub-index. If the difference between the previous floor level and the actual position is more than 50mm, LIMAX Safe SG/SC will refuse to adjust the floor level and responds with the SDO abort service (abort code: 0601 0000h – Unsupported access to an object).

Read out the floor table

A read access to this object always returns the level of the specified floor.

If no floor is learned on this sub-index, LIMAX Safe SG/SC responds with the SDO abort service (abort code: 0800 0024h – No data available). If the requested sub-index is outside the valid range (>127) LIMAX Safe SG/SC responds with the SDO abort transfer service (abort code: 0609 0011h – Sub-index does not exist).

VALUE DEFINITION

Sub-index 0 contains the number of floors actually stored in LIMAX Safe SG/SC.
 Sub-indices 1 to 127 contain the floor level of the corresponding floors.

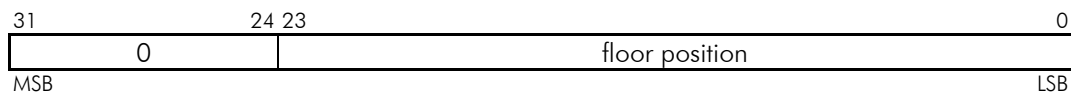

Fig. 6: Floor table object entry

The data fields have the following meaning:

floor position Position of the current floor

Table 10: Structure of a floor table object entry when reading

Bit	Value	Meaning
0 - 23		Absolute floor position in multiples of 1 mm
24 - 31		reserved (always 0)

In order to store a floor, the keyword “SETF” has to be written to the appropriate sub-index.

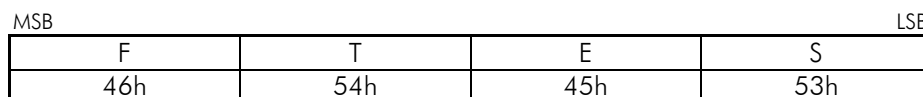

Fig. 7: Set floor keyword

To adjust a floor, the keyword “ADJF” has to be written to the appropriate sub-index.

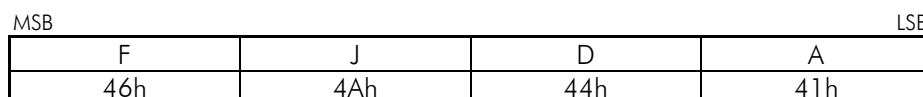

Fig. 8: Adjust floor keyword

OBJECT DESCRIPTION

Index	2140h
Name	Floor table
Object code	ARRAY
Data type	UNSIGNED32

ENTRY DESCRIPTION

Sub-index	00h
Description	Number of floors
Access	ro
PDO mapping	No
Value range	0 to 127
Default value	0

Sub-index	01h to 7Fh
Description	Floor level
Access	rw
PDO mapping	No
Value range	see <i>value definition</i>
Default value	No

4.14 Object 2148h: Floor table of the control

This object is used to compare the floor table between LIMAX Safe SG/SC and the control. The aim of this object is to avoid LIMAX Safe SG/SC to learn additional (not existent) floors or floors far apart the exact floor position.

The object has a nearly identical structure as the floor table, object 2140h. The control has to write its shaft image to this object. The number of floors and their positions are compared. If the number does not match or the position difference is more than 50 mm, the safety circuit would be opened.

4.14.1 Behavior in pre-commissioning mode

In pre-commissioning mode the internal floor table is not compared with the floor table of the control.

4.14.2 Behavior teach mode

During teach mode the internal floor table is not compared with the floor table of the control. When teach mode is left all relays will open. If every used¹ sub-index is refreshed and comparison between object 2140h and 2148h is valid, all relays close.

4.14.3 Behavior in normal mode

Each used entry of the floor table of the control has to be refreshed once every five minutes. When one entry is not refreshed within this time window, the safety circuit is opened until the appropriate sub-index has been updated.

If the number of floors does not match, or a floor position of LIMAX Safe SG/SC are more than 50 mm apart from the floor position of the control a defect (Level 1) is triggered and OC will open at the next floor.

¹ used sub-index means 0 ... n where n is the highest floor number used.

4.14.4 Behavior in Adjustment mode

In adjustment mode the behavior is the same as in normal mode

4.14.5 Reading the floor table of the control

To simplify debugging problems, some flags indicate, whether the object entry was refreshed within the last five minutes or not, whether the number of floors correspond between control and LIMAX Safe SG/SC and whether the differences between the floor positions of control and their corresponding floor positions of LIMAX Safe SG/SC are in the valid range or not.

VALUE DEFINITION

Sub-index 0 should contain the highest floor number actually stored in the control.

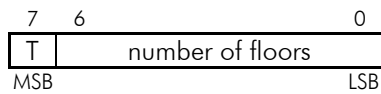

Fig. 9: Number of floors in the control object entry

The data fields have the following meaning:

- T Timeout flag This bit is set to 1 when the number of floors were not refreshed within the last five minutes. The flag is cleared otherwise.

- number of floors The number of floors currently taught in the control. The valid range reaches from 0 to 127.

Sub-indices 1 to 127 contain the floor levels of the corresponding floors.

See Fig. 6 for details about the structure.

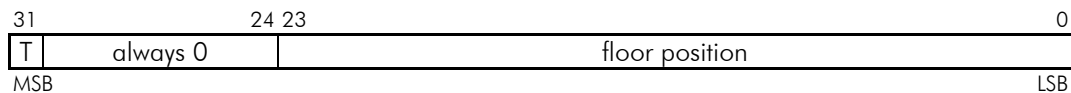

Fig. 10: Floor table of the control object entry

The data fields have the following meaning:

- T Timeout flag This bit is set to 1 when the floor position was not refreshed within the last five minutes. The flag is cleared otherwise.

- floor position The position of the corresponding floor. The value is given in multiples of 1 mm

OBJECT DESCRIPTION

Index	2148h
Name	Floor table of control
Object code	ARRAY
Data type	UNSIGNED32

ENTRY DESCRIPTION

Sub-index	00h
Description	Number of floors in the control
Access	rw
PDO mapping	No
Value range	see <i>value definition</i>
Default value	0

Sub-index	01h to 7Fh
Description	Floor levels in the control
Access	rw
PDO mapping	No
Value range	see <i>value definition</i>
Default value	No

4.15 Object 2150h: Fault register

This object shows the faults which are present.

Reading this object shows the actual state of the faults. A one signals a currently active fault. A zero signals an inactive fault. Faults which reset automatically will be read as zero when the fault condition disappears.

Some faults do not reset by themselves. These faults may be reset manually.

This object is mapped to TPDO 2 by default.

VALUE DEFINITION

Each bit in sub-index 0 represents a fault.

The reset column shows how a specific fault is cleared. The values have the following meaning:

- A Fault is cleared automatic after the fault condition has been disappeared
- A10 Fault is cleared after 10s standstill
- M Fault is cleared manually by use of the reset input

Table 11: Fault register layout

Bit	Abbr.	Fault	Reset
0	NORM_TOP_LIM	Normal mode top limit switch	A
1	NORM_BOT_LIM	Normal mode bottom limit switch	A
2	MAINT_TOP_LIM	Maintenance top limit switch	A
3	MAINT_BOT_LIM	Maintenance bottom limit switch	A
4 - 7		reserved	
8	NORM_OVERSP_PRE_TRIP	Normal mode over-speed (pre-tripping)	M
9	NORM_OVERSP_FIN_TRIP	Normal mode over-speed (final tripping)	M
10	MAINT_OVERSP	Maintenance mode over-speed (+ 5%)	A10
11		reserved	
12	TEACH_OVERSP	Teach mode over-speed	A10
13 - 15		reserved	
16	NORM_DECEL	Normal mode deceleration event (level 1,4 m/s ²)	A10
17		reserved	
18		reserved	
19	FLTBL_CMP_TIMEOUT	Floor table compare timeout. The control has not updated object 2148h for more than the allowed time.	A
20	MAINT_UP_CONTR	Car should move upwards in maintenance but downward movement was detected	A
21	MAINT_DOWN_CONTR	Car should move downwards in maintenance but upward movement was detected	A
22	MAINT_STOP_CONTR	Car should be in standstill, but movement was detected in maintenance	A
23		reserved	
24	UCM	Unintended car movement	M
25 - 31		reserved	

OBJECT DESCRIPTION

Index	2150h
Name	Fault table
Object code	VAR
Data type	UNSIGNED32

ENTRY DESCRIPTION

Sub-index	00h
Access	ro
PDO mapping	TPDO for reading the fault register, mapped to TPDO 2 by default
Value range	see <i>value definition</i>
Default value	No

4.16 Object 2158h: Defect log channel B

This object shows the log of active defects of the full CAN channel.

4.16.1 Error levels

In case LIMAX Safe SG/SC detects a defect it sets an error level. The goal of the different error levels is always to react as soft as possible in case a defect occurs.

The following error levels are defined:

Table 12: Error levels and their relay action

Level	Reaction
0	no error
1	no relay reaction during elevator moves. As soon as the elevator comes to standstill, a transition to error level 2 takes place (open OC)
2	open OC at once
3	open OC and NOC at once (keep NOC open, regardless of the door state and door over-bridging state)
4	open OC, NOC and SGC at once

In order to determine which reaction is necessary one has to look at the inputs and outputs of the safety functions, refer to the operation manual for further information about safety functions.

In case the defect affects an input which is necessary for a safety function acting SGC, SGC must be opened if the defect occurs.

In case the defect affects an input which is only necessary for safety functions acting OC, but not for NOC and SGC, only OC must be opened if the defect occurs.

In case a new defect occurs while there is already a defect present, the levels are compared. If the new defect has a higher error level than the current error level the current error level is increased to the level which is defined for the new defect. If the level of the new defect is less or equal to the current error level, the error level does not change.

4.16.2 Non volatile storing and reset of the error level

A detected defect must not be reset by power cycle. A defect reset should only be done by the intention of a skilled person.

Therefore the error level will be stored in the EEPROM. It is kept after power cycle.

The reset is only carried out if there is no defect present at the moment.

4.16.3 Non volatile storing and reset of UCM and over-speed fault

It is a demand of the EN81 that UCM and over-speed in normal mode must not be reset by power cycle. The reset should be done by a skilled person.

Therefore it is the easiest way to implement this demand to treat them like defects (although they are no defects but faults of lift operation).

In case of over-speed in normal mode error level 2 is set. In case of UCM error level 4 is set.

4.16.4 Object description

VALUE DEFINITION

Sub-index 0 contains the highest sub-index that is supported: contains information how many entries are there in the log (refer to sub-index 10h..FFh):

- 0Fh: no entry
- 17h: one entry
- 1Fh: two entries
-
- FFh: 30 entries (maximum)

Sub-index 1 contains information about the defect and warning status.

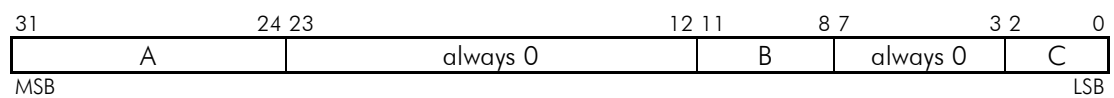

Fig. 11: Structure of the defect status register

The data fields have the following meaning:

- A Counter of position warnings: counts how many single position leaps occurred (software was able to filter them without setting an error level)
- B Error level as read from the EEPROM at last power up
- C Current error level

Sub-Index 2 contains the system voltage levels of the Safe Box (raw values).

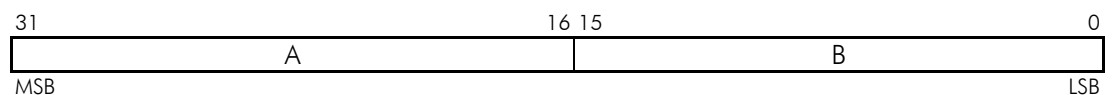

Fig. 12: Structure of the system voltage register

The data fields have the following meaning:

- A Raw value of the relay supply. The value is given in multiples of 16,9 mV
- B Relative raw value of the 3,3 V power supply of the other channel. The value is given in multiples of 1,21 mV

Sub-indices 3 to 12 contain statistical information about the program flow:

Sub-index 3 reports the maximum time for one safety-interrupt. The value is given in multiples of 1 μ s.

Sub-index 4 reports the maximum time between two safety-interrupts. The value is given in multiples of 1 μ s.

Sub-index 5 reports the maximum time for one cycle of the main loop. The value is given in multiples of 1 μ s.

Sub-index 6 reports the maximum time between two interrupts of the fast timer (polling safety circuit). The value is given in multiples of 1 μ s.

Sub-index 7 reports the maximum and minimum time between two UART-Interrupts from sensor RS485. The high word contains the minimum time, the low word contains the maximum time. The values are given in multiples of 1 μ s.

Sub-index 8 reports the maximum time for synchronization with the second channel. The value is given in multiples of 1 μ s.

Sub-index 9 reports the maximum time for one 16-bit data exchange cycle between the two channels. The value is given in multiples of 1 μ s.

Sub-index 10 reports the maximum time for one system timer interrupt and the maximum number of system timer interrupts between two safety interrupts. The high word contains the maximum number of system timer interrupts between two safety interrupts, the low word contains the maximum time for one system timer interrupt. The values are given in multiples of 1 μ s.

Sub-index 11 reports the elapsed time since the last finish of the ROM test. The value is given in multiples of 1 ms.

Sub-index 12 reports the elapsed time since the last finish of the RAM test. The value is given in multiples of 1 ms.

Sub-index 13 indicates if the magnitude of capacitive coupling to the door input is small enough to be evaluated as safe. While doors are open, the value of this sub-index must increase once per second to be safe. If the value is reset to 0 while doors are open, the magnitude of capacitive coupling is dangerous.

Please have a look into the operating manual for further details about the check on capacitive coupling.

Sub-Indices 14 and 15 are reserved. On read access LIMAX Safe SG/SC will respond with the SDO abort transfer service (abort code: 0609 0011h – Sub-index does not exist).

Sub-Indices 10h to FFh contain more information about the defects occurred. Each 8 sub-indices together contain an entry in the log (sub-indices 10h to 17h, 18h to 1Fh and so forth). The structure of a log entry looks as follows:

Sub-index offset	31	16	15	0
0	Error code			
1	Event time high double word			
2	Event time low double word			
3	Last position		Current Position	
4	Last but two position		Last but one position	
5	Velocity		Last but three position	
6	Inputs of the safety function			
7	Outputs of the safety function			

Fig. 13: Structure of a log entry

The fields have the following meaning:

- Error code: unique code that refers to the defect/fault type (see Table 13)
- Event time: Time (since last power up), when the defect/fault happens. The value is given in multiples of 1 μ s
- Positions: The last five positions before the event. The value is given in multiples of 4 mm
- Velocity: The current velocity when the event occurred. The value is given in multiple of 1 mm/s
- Inputs: Inputs of the safety function
- Outputs: Outputs of the safety function

For example the velocity of the 2nd log entry is stored in the high word of sub-index 1Dh (18h + 5).

The newest entries are always stored at the highest valid sub-indices (see sub-index 0).

The log information gets lost at power cycle.

Table 13: Error code meanings

Error code	Meaning
1h	Overspeed
2h	Unintended car movement (UCM)
3h	Overspeed 30%
101h	Failed to initialize the sensor communication during power up
104h	Too much position extrapolations (caused by communication error)
105h	General sensor error
107h	Too much communication errors between sensor and Safe Box
108h	Sensor communication timeout
40Ah	SGC feedback input did not follow SGC output when opening SGC
40Bh	SGC feedback input did not follow SGC output when closing SGC
640h	Difference between floor table and floor table in the control
901h	Explicit OC test failed
902h	Implicit OC test failed

There exist more error codes. Only some examples are shown here. For the complete list refer to the instruction manual.

OBJECT DESCRIPTION

Index	2158h
Name	Defect table
Object code	ARRAY
Data type	UNSIGNED32

ENTRY DESCRIPTION

Sub-index	00h
Description	Highest sub-index supported
Access	ro
PDO mapping	No
Value range	0Fh to FFh

Sub-index	01h
Description	Error code
Access	ro
PDO mapping	No
Value range	see <i>value definition</i>
Default value	No

Sub-index	02h
Description	System voltage levels
Access	ro
PDO mapping	No
Value range	see <i>value definition</i>
Default value	No

Sub-index	03h
Description	Maximum time for one safety interrupt
Access	ro
PDO mapping	No
Value range	see <i>value definition</i>
Default value	No

Sub-index	04h
Description	Maximum time between two safety interrupts
Access	ro
PDO mapping	No
Value range	see <i>value definition</i>
Default value	No

Sub-index	05h
Description	Maximum time for one cycle of the main loop
Access	ro
PDO mapping	No
Value range	see <i>value definition</i>
Default value	No

Sub-index	06h
Description	Maximum time between two interrupts of the fast timer
Access	ro
PDO mapping	No
Value range	see <i>value definition</i>
Default value	No

Sub-index	07h
Description	Time between two RS485 interrupts
Access	ro
PDO mapping	No
Value range	see <i>value definition</i>
Default value	No

Sub-index	08h
Description	Maximum time for synchronization with the second channel
Access	ro
PDO mapping	No
Value range	see <i>value definition</i>
Default value	No

Sub-index	09h
Description	Maximum time for one 16-bit data exchange cycle between the two channels
Access	ro
PDO mapping	No
Value range	see <i>value definition</i>
Default value	No

Sub-index	0Ah
Description	System interrupt times
Access	ro
PDO mapping	No
Value range	see <i>value definition</i>
Default value	No

Sub-index	0Bh
Description	Time elapsed since the last finish of the ROM-test
Access	ro
PDO mapping	No
Value range	see <i>value definition</i>
Default value	No

Sub-index	0Ch
Description	Time elapsed since the last finish of the RAM-test
Access	ro
PDO mapping	No
Value range	see <i>value definition</i>
Default value	No

Sub-index	0Dh
Description	Counter used to check the magnitude of capacitive coupling on door contact state input
Access	ro
PDO mapping	No
Value range	see <i>value definition</i>
Default value	No

Sub-index	10h to 17h
Description	1 st log entry
Access	ro
PDO mapping	No
Value range	see <i>value definition</i>
Default value	No

Sub-index	18h to 1Fh
Description	2 nd log entry
Access	ro
PDO mapping	No
Value range	see <i>value definition</i>
Default value	No

...

Sub-index	F8h to FFh
Description	30 th log entry
Access	ro
PDO mapping	No
Value range	see <i>value definition</i>
Default value	No

4.17 Object 2159h: Defect log channel A

This object contains the defect log of channel A, which is not capable to send data over CAN by itself. The structure of this object is the same as in object 2158h.

4.18 Object 215Ch: Sensor error registers

This object contains the sensor error registers. The content of this register is only to inform the manufacturer about an error and not described in detail in this specification.

VALUE DEFINITION

- Sub-index 0 contains the highest sub-index in this object.
- Sub-index 1 contains the error register value of sensor channel A
- Sub-index 2 contains the error register value of sensor channel B

OBJECT DESCRIPTION

Index	215Ch
Name	Sensor error registers
Object code	ARRAY
Data type	UNSIGNED32

ENTRY DESCRIPTION

Sub-index	00h
Description	Highest sub-index supported
Access	ro
PDO mapping	no
Value range	2
Default value	2

Sub-index	01h
Description	Error register content of sensor channel A
Access	ro
PDO mapping	no
Value range	UNSIGNED32
Default value	0 (if no error is present)

Sub-index	02h
Description	Error register content of sensor channel B
Access	ro
PDO mapping	no
Value range	UNSIGNED32
Default value	0 (if no error is present)

4.19 Object 215Dh: Sensor statistics

This object contains statistics of internal sensor data. This information is not meant to interpret by the customer and therefore not described in detail in this specification.

VALUE DEFINITION

- Sub-index 0 contains the highest sub-index in this object.
- Sub-indices 1 to 128 contain statistical data of both channels.

OBJECT DESCRIPTION

Index	215Dh
Name	Sensor statistics
Object code	ARRAY
Data type	UNSIGNED16

ENTRY DESCRIPTION

Sub-index	00h
Description	Highest sub-index supported
Access	ro
PDO mapping	no
Value range	80h
Default value	80h

Sub-index	01h to 80h
Description	Statistical data of internal sensor values
Access	ro
PDO mapping	no
Value range	UNSIGNED16

4.20 Object 21E0h: Rated Speed / (pre-)tripping speed

This object contains rated speed, pre-tripping speed and final tripping speed of the device

VALUE DEFINITION

Sub-index 0 contains the highest sub-index in this object.

Sub-indices 1 to 3 contain the rated speed, pre-tripping speed and final tripping speed, all in mm/s. In case initialization of rated speed failed at power up, rated speed, pre-tripping speed and final tripping speed contain the value 0.

OBJECT DESCRIPTION

Index	21E0h
Name	Rated Speed / (pre-)tripping speed
Object code	ARRAY
Data type	UNSIGNED16

ENTRY DESCRIPTION

Sub-index	00h
Description	Highest sub-index supported
Access	ro
PDO mapping	no
Value range	03h
Default value	03h

Sub-index	01h
Description	Rated speed [mm/s]
Access	ro
PDO mapping	no
Value range	0 or 100 ... 10000

Sub-index	02h
Description	Pre-tripping speed [mm/s]
Access	ro
PDO mapping	no
Value range	0 or 600 ... 11500

Sub-index	03h
Description	Tripping speed [mm/s]
Access	ro
PDO mapping	no
Value range	0 or 800 ... 12525

4.21 Object 21E1h: Brake Type

This object contains the brake type (SG or SC) of the device

VALUE DEFINITION

Table 14: Structure of the type SG/SC register

Value	Meaning
01234567h	LIMAX Safe SG/SC is of the type SG
89ABCDEFh	LIMAX Safe SG/SC is of the type SC
00000000h	initialization of type at power up failed

OBJECT DESCRIPTION

Index	21E1h
Name	Type SG/SC
Object code	VAR
Data type	UNSIGNED32

ENTRY DESCRIPTION

Sub-index	00h
Description	SG/SC
Access	ro
PDO mapping	no
Value range	See value definition

5 Communication objects

5.1 Transmit PDOs

5.1.1 TPDO 1

This PDO transmits asynchronously the values of the position, speed and the I/O state register. The TPDO 1 is transmitted in the NMT operational state. The following section specifies the object description of the PDO communication parameter and the associated entry description. The values are defined in /CiA301/.

Fig. 14 shows an overview of the mapping of TPDO 1

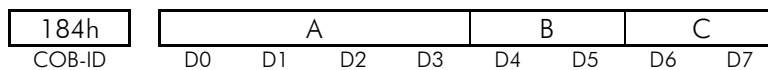

Fig. 14: TPDO 1 structure (default settings for node-ID 4)

Where the data fields have the following meaning:

- A Position (Object 6004h, sub-index 00h)
- B Speed (Object 6030h, sub-index 01h)
- C I/O state and mode register (Object 2100h, sub-index 00h ↗ 4.1)

OBJECT DESCRIPTION

Index	1800h
Name	TPDO 1 communication parameter
Object code	Record
Data type	PDO communication parameter record

ENTRY DESCRIPTION

Sub-index	00h
Description	Highest sub-index supported
Access	ro
PDO mapping	No
Value range	05h
Sub-index	01h
Description	COB-ID
Access	ro
PDO mapping	No
Value range	See /CiA301/
Sub-index	02h
Description	Transmission type
Access	rw
PDO mapping	No
Value range	See /CiA301/
Default value	254

Sub-index	03h
Description	Inhibit time
Access	rw
PDO mapping	No
Value range	See /CiA301/
Default value	100

Sub-index	05h
Description	Event timer
Access	rw
PDO mapping	No
Value range	See /CiA301/
Default value	10

The following section specifies the PDO mapping parameters and the associated entry description.

OBJECT DESCRIPTION

Index	1A00h
Name	TPDO 1 mapping parameter
Object code	Record
Data type	PDO mapping parameter record

ENTRY DESCRIPTION

Sub-index	00h
Description	Highest sub-index supported
Access	rw (constant in NMT operational state)
PDO mapping	No
Value range	00h to 08h
Default value	03h

Sub-index	01h
Description	1 st Application object (Position value)
Access	rw
PDO mapping	No
Value range	See /CiA301/
Default value	6004 00 20h

Sub-index	02h
Description	2 nd Application object (Speed value)
Access	rw
PDO mapping	No
Value range	See /CiA301/
Default value	6030h 01 10h

Sub-index	03h
Description	3 rd Application object (I/O state and mode register value) ↗ 4.1
Access	rw
PDO mapping	No
Value range	See /CiA301/
Default value	2100 00 10h

5.1.2 TPDO 2

This PDO transmits asynchronously the contents of the fault register object. The TPDO 2 is transmitted in the NMT operational state. The following section specifies the object description of the PDO communication parameter and the associated entry description. The values are defined in /CiA301/.

Fig. 15 shows an overview of the mapping of TPDO 2

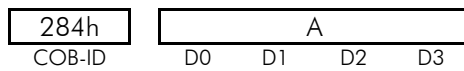

Fig. 15: TPDO 2 structure (default settings for node-ID 4)

Where the data fields have the following meaning:

A Fault register (Object 2150h, sub-index 0 ↗ 4.15)

OBJECT DESCRIPTION

Index	1801h
Name	TPDO 2 communication parameter
Object code	Record
Data type	PDO communication parameter record

ENTRY DESCRIPTION

Sub-index	00h
Description	Highest sub-index supported
Access	ro
PDO mapping	No
Value range	05h

Sub-index	01h
Description	COB-ID
Access	ro
PDO mapping	No
Value range	See /CiA301/

Sub-index	02h
Description	Transmission type
Access	rw
PDO mapping	No
Value range	See /CiA301/
Default value	254

Sub-index	03h
Description	Inhibit time
Access	rw
PDO mapping	No
Value range	See /CiA301/
Default value	0

Sub-index	05h
Description	Event timer
Access	rw
PDO mapping	No
Value range	See /CiA301/
Default value	5

The following section specifies the PDO mapping parameters and the associated entry description.

OBJECT DESCRIPTION

Index	1A01h
Name	TPDO 2 mapping parameter
Object code	Record
Data type	PDO mapping parameter record

ENTRY DESCRIPTION

Sub-index	00h
Description	Highest sub-index supported
Access	rw (constant in NMT operational state)
PDO mapping	No
Value range	00h to 08h
Default value	01h

Sub-index	01h
Description	1 st Application object (Fault register) ↗ 4.15
Access	rw
PDO mapping	No
Value range	See /CiA301/
Default value	2150 01 20h

5.1.3 TPDO 3

This PDO transmits asynchronously the handshaking messages for the relay test. The TPDO 3 is transmitted in the NMT operational state. The following section specifies the object description of the PDO communication parameter and the associated entry description. The values are defined in /CiA301/.

Fig. 16 shows an overview of the mapping of TPDO 3

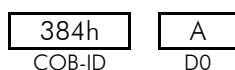

Fig. 16: TPDO 2 structure (default settings for node-ID 4)

Where the data fields have the following meaning:

- A Relay test (Object 2128h, sub-index 0 ↗ 4.9)

OBJECT DESCRIPTION

Index	1802h
Name	TPDO 3 communication parameter
Object code	Record
Data type	PDO communication parameter record

ENTRY DESCRIPTION

Sub-index	00h
Description	Highest sub-index supported
Access	ro
PDO mapping	No
Value range	05h

Sub-index	01h
Description	COB-ID
Access	ro
PDO mapping	No
Value range	See /CiA301/

Sub-index	02h
Description	Transmission type
Access	rw
PDO mapping	No
Value range	See /CiA301/
Default value	254

Sub-index	03h
Description	Inhibit time
Access	rw
PDO mapping	No
Value range	See /CiA301/
Default value	0

Sub-index	05h
Description	Event timer
Access	rw
PDO mapping	No
Value range	See /CiA301/
Default value	0 (cyclic transmission disabled)

The following section specifies the PDO mapping parameters and the associated entry description.

OBJECT DESCRIPTION

Index	1A02h
Name	TPDO 3 mapping parameter
Object code	Record
Data type	PDO mapping parameter record

ENTRY DESCRIPTION

Sub-index	00h
Description	Highest sub-index supported
Access	rw (constant in NMT operational state)
PDO mapping	No
Value range	00h to 08h
Default value	01h

Sub-index	01h
Description	1 st Application object (Relay test) ↗ 4.9
Access	rw
PDO mapping	No
Value range	See /CiA301/
Default value	2128 01 08h

5.2 Receive PDOs

5.2.1 RPDO 1

This PDO is received asynchronously to enable door over-bridging. The RPDO 1 is evaluated only in the NMT operational state. The following section specifies the object description of the PDO communication parameter and the associated entry description. The values are defined in /CiA301/.

Fig. 17 shows an overview of the mapping of RPDO 1

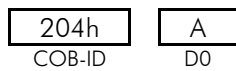

Fig. 17: RPDO 1 structure (default settings for node-ID 4)

Where the data fields have the following meaning:

- A Over-bridging door safety (Object 2120h, sub-index 00h)

OBJECT DESCRIPTION

Index	1400h
Name	RPDO 1 communication parameter
Object code	RECORD
Data type	PDO communication parameter record

ENTRY DESCRIPTION

Sub-index	00h
Description	Highest sub-index supported
Access	ro
PDO mapping	No
Value range	05h

Sub-index	01h
Description	COB-ID used by RPDO
Access	rw
PDO mapping	No
Value range	See /CiA301/

Sub-index	02h
Description	Transmission type
Access	rw
PDO mapping	No
Value range	See /CiA301/
Default value	254

Sub-index	03h
Description	Inhibit time
Access	rw
PDO mapping	No
Value range	See /CiA301/
Default value	0

Sub-index	05h
Description	Event timer
Access	rw
PDO mapping	No
Value range	See /CiA301/
Default value	0 (monitoring disabled)

The following section specifies the PDO mapping parameters and the associated entry description.

OBJECT DESCRIPTION

Index	1600h
Name	RPDO 1 mapping parameter
Object code	RECORD
Data type	PDO mapping parameter record

ENTRY DESCRIPTION

Sub-index	00h
Description	Highest sub-index supported
Access	rw (constant in NMT operational state)
PDO mapping	No
Value range	00h to 08h
Default value	01h

Sub-index	01h
Description	1 st application object (Over-bridging door safety)
Access	rw
PDO mapping	No
Value range	See /CiA301/
Default value	2120 00 08h

5.2.2 RPDO 2

This PDO is not used by default.

5.2.3 RPDO 3

This PDO receives asynchronously the handshaking messages for the relay test. The RPDO 3 is evaluated only in the NMT operational state. The following section specifies the object description of the PDO communication parameter and the associated entry description. The values are defined in /CiA301/.

Fig. 18 shows an overview of the mapping of RPDO 3

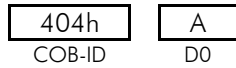

Fig. 18: RPDO 3 structure (default settings for node-ID 4)

Where the data fields have the following meaning:

- A Relay test (Object 2128h, sub-index 0)

OBJECT DESCRIPTION

Index	1402h
Name	RPDO 3 communication parameter
Object code	RECORD
Data type	PDO communication parameter record

ENTRY DESCRIPTION

Sub-index	00h
Description	Highest sub-index supported
Access	ro
PDO mapping	No
Value range	05h

Sub-index	01h
Description	COB-ID used by RPDO
Access	rw
PDO mapping	No
Value range	See /CiA301/

Sub-index	02h
Description	Transmission type
Access	rw
PDO mapping	No
Value range	See /CiA301/
Default value	254

Sub-index	03h
Description	Inhibit time
Access	rw
PDO mapping	No
Value range	See /CiA301/
Default value	0

Sub-index	05h
Description	Event timer
Access	rw
PDO mapping	No
Value range	See /CiA301/
Default value	0 (monitoring disabled)

The following section specifies the PDO mapping parameters and the associated entry description.

OBJECT DESCRIPTION

Index	1602h
Name	RPDO 3 mapping parameter
Object code	RECORD
Data type	PDO mapping parameter record

ENTRY DESCRIPTION

Sub-index	00h
Description	Highest sub-index supported
Access	rw (constant in NMT operational state)
PDO mapping	No
Value range	00h to 08h
Default value	01h

Sub-index	01h
Description	1 st application object (Relay test)
Access	rw
PDO mapping	No
Value range	See /CiA301/
Default value	2128 01 08h

6 Error handling

6.1 Error appearance

Each time an error occurs in LIMAX Safe SG/SC, it writes a new entry in the pre-defined error field (Object 1003h), the applicable flag in the error register (Object 1001h, see Table 15) is set and an emergency message containing the error code (see Table 16) and the actual value of the error register is transmitted to the control. For more information about the pre-defined error field and the error register see /CiA301/.

6.2 Error clearing

Some errors are cleared automatically when they are no longer present. The others must be cleared by the control by set the length of the pre-defined error field (object 1003h, sub-index 00h) to zero. All errors that are no longer present would disappear now.

6.3 Object 1001h: Error register

Table 15: Structure of the error register

Bit	Meaning
0	Generic error
1	Current
2	Voltage
3	Temperature
4	Communication error
5	Device profile specific
6	reserved (always 0b)
7	manufacturer specific

For further information of the error register see /CiA301/.

6.4 Emergency error codes

Table 16: Emergency error codes

Error code	Error flag	Description
1001h	7	No tape error
8110h	4	CAN overrun
8130h	4	Consumer heartbeat error
8140h	4	Recovered from bus off
8210h	4	RPDO too short
8220h	4	RPDO too long

A Object dictionary overview

(informative)

Table 17: Object dictionary overview

Index	Name
1000h	Device type
1001h	Error register
1003h	Pre-defined error field
1008h	Manufacturer device name
1009h	Manufacturer hardware version
100Ah	Manufacturer software version
1010h	Store parameters
1011h	Restore default parameters
1014h	COB-ID EMCY
1015h	Inhibit time EMCY
1016h	Consumer heartbeat time
1017h	Producer heartbeat time
1018h	Identity object
1200h	1st SDO server parameter
1400h	1st RPDO communication parameter
1401h	2nd RPDO communication parameter
1402h	3rd RPDO communication parameter
1600h	1st RPDO mapping parameter
1601h	2nd RPDO mapping parameter
1602h	3rd RPDO mapping parameter
1800h	1st TPDO communication parameter
1801h	2nd TPDO communication parameter
1802h	3rd TPDO communication parameter
1A00h	1st TPDO mapping parameter
1A01h	2nd TPDO mapping parameter
1A02h	3rd TPDO mapping parameter
2100h	I/O state register
210Fh	Device information
2110h	Door zone size
2111h	Limit switches and limit switch indicator position offsets
2112h	NOC test parameter
2120h	Over-bridging door contact (8-bit object, up to 63 floors)
2121h	Over-bridging door contact (16-bit object, more than 63 floors)
2124h	Temporary reference position for limit switches
2128h	Relay test
2129h	OC test
212Ah	Direct relay access
212Fh	Safe Box special functions
2140h	Floor table
2148h	Floor table in the control
2150h	Fault register
2158h	Defect log channel B
2159h	Defect log channel A
215Ch	Sensor error register

Index	Name
215Dh	Sensor statistics
21E0h	Rated speed / tripping speed
21E1h	Brake type (SG/SC)
6000h	Operating parameters
6004h	Position value
6005h	Linear encoder measuring step settings
6030h	Speed value
6500h	Operating status
6501h	Measuring step

B Communication sequence examples

B.1 Start-up

The following diagram shows an example of the start-up sequence.

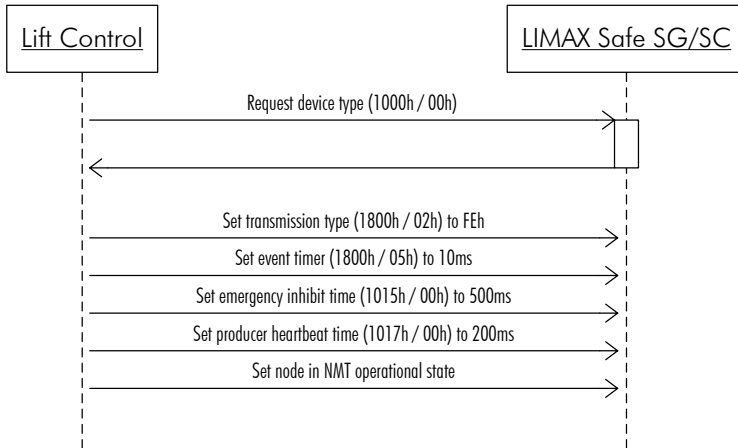

Fig. 19: Sequence diagram start-up (example)

B.2 Teach procedure

The following example shows the teaching procedure and the relevant communication between LIMAX Safe SG/SC and the control.

The number of floors in this example is 14.

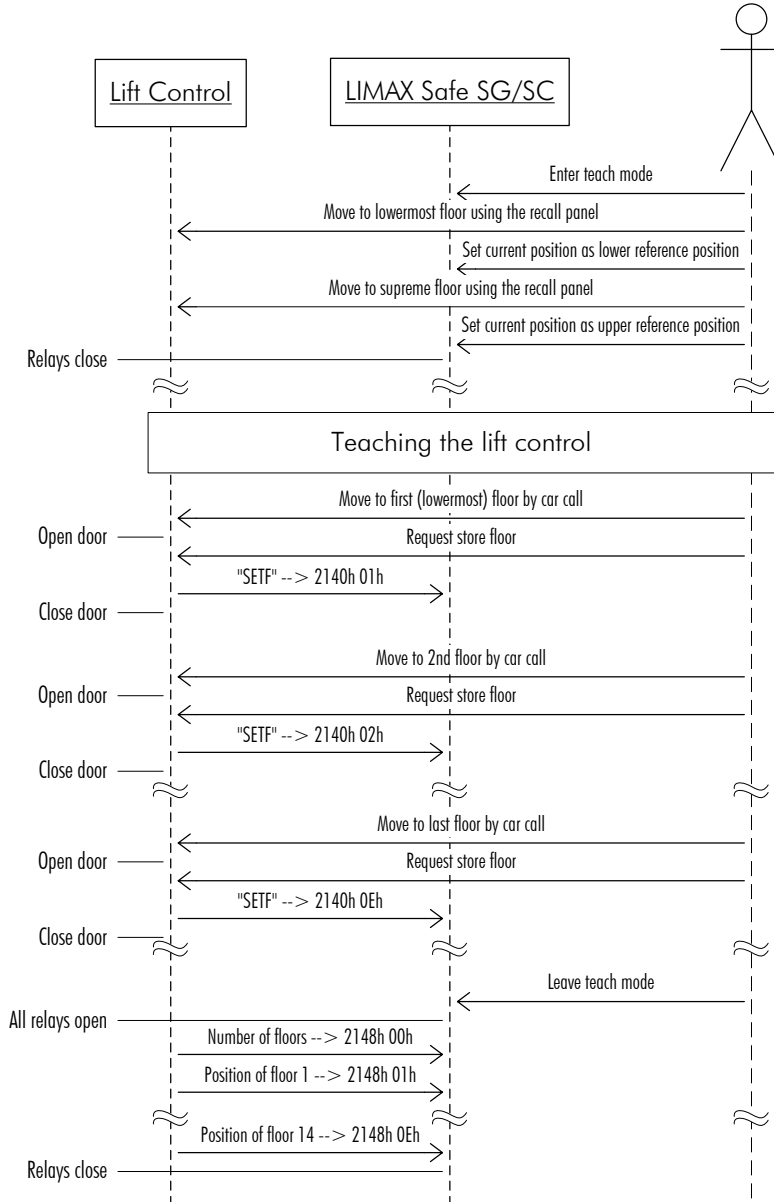

Fig. 20: Sequence diagram teach procedure (example)

B.3 Door over-bridging communication

In this example some passengers are already inside the car at floor level 2 at beginning. Their target floor is 6. After they have reached floor 6 and left the car, another passenger calls the car from floor 4.

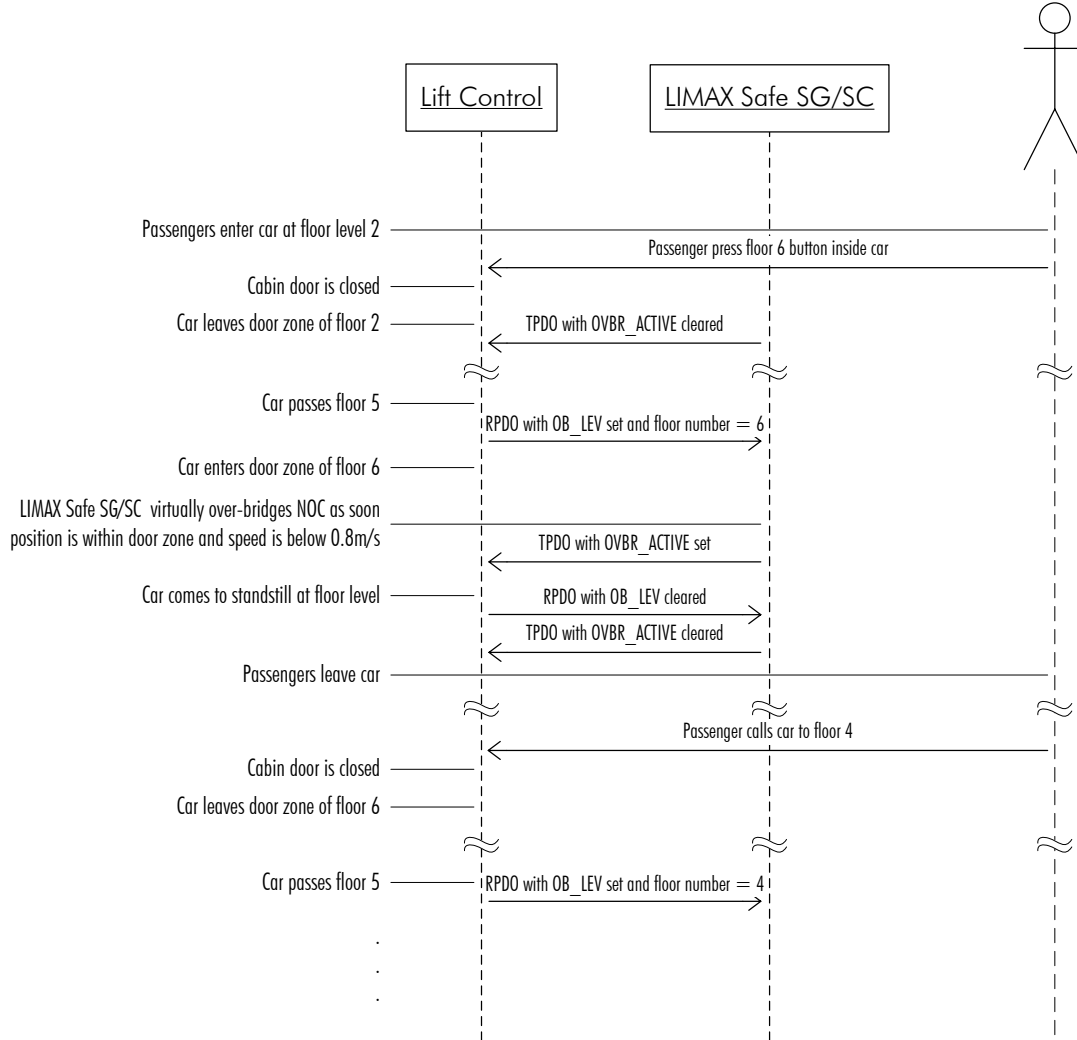

Fig. 21: Sequence diagram door over-bridge (example)

Since a door over-bridge command is assigned to a floor, it doesn't matter in at which moment the control enables door over-bridging. In the example above it is sent after the car has passed the floor just before the target floor. Disabling door over-bridging should happen when the car comes to standstill at floor level.

To re-leveling, the control has to set OB_ADJ before the cabin moves and to clear this bit when the car comes to standstill at floor level again.

B.4 Relay test communication

The following sequence diagram describes the communication between LIMAX Safe SG/SC and the control to perform a test of the safety gear / speed governor relay.

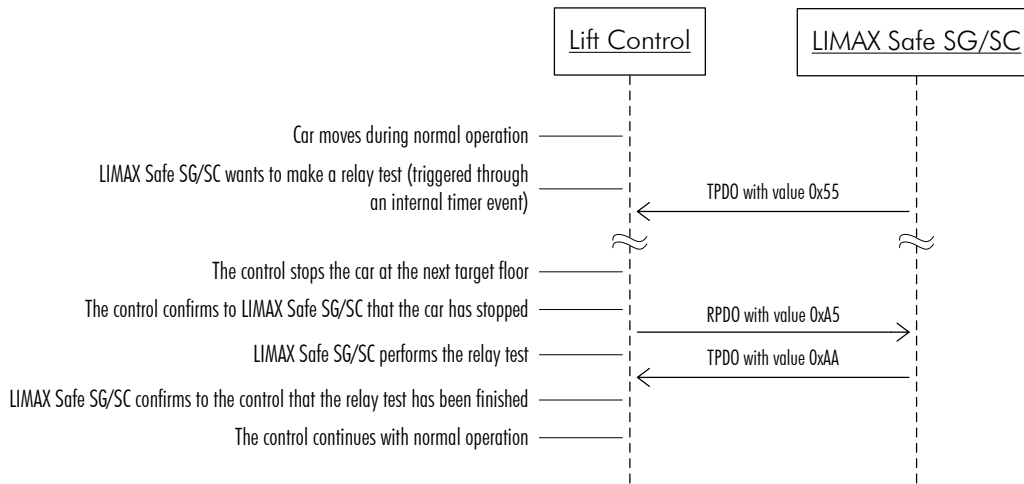

Fig. 22: Sequence diagram relay test

C Distance relations

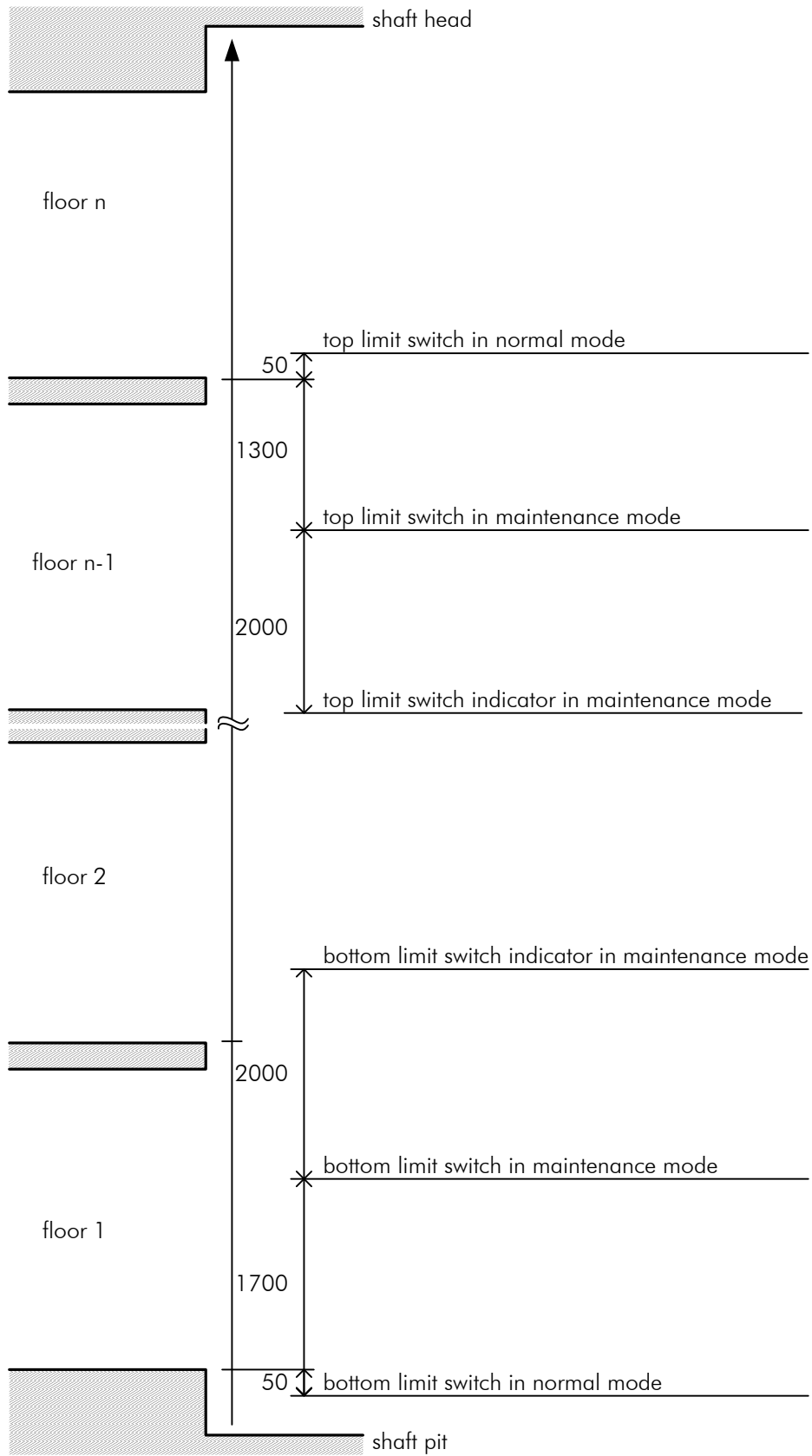

Fig. 23: Distance relations between floor positions and limit switches. All distances are default values which can be adjusted in object 2111h.

D CANopen keywords

(informative)

This chapter contains an overview of all CANopen keyword values.

Table 18: CANopen keywords

Keyword	Value	Object	Meaning
SETL	4C544553h	2124h	Set upper or lower reference position.
SETF	46544553h	2140h	Set the current position as floor position
ADJF	464A4441h		Adjust the floor position to the current position

E CANopen basics

In this appendix the basic communication format and configuration of the most important parameters of CANopen devices are described.

The device which has to be configured is called CANopen device. If not otherwise stated, all numbers are to be interpreted hexadecimal.

E.1 Contents

E.2	Initial Operation	52
E.3	Command Descriptions	52
E.3.1	General Transfer of Service Data Objects (SDO)	53
E.3.1.1	Read object	53
E.3.1.2	Write objects.....	54
E.3.1.3	Abort Transfer.....	54
E.3.2	Regular mode	55
E.3.2.1	Setting the Heartbeat Cycle Duration	55
E.3.2.2	Setting the Sending Cycle for the position data	56
E.3.2.3	Saving the parameters	56
E.3.3	Changing the Operating Modes	57
E.3.3.1	Changing the device into the Operational Mode	57
E.3.3.2	Changing the device into the Pre-operational Mode.....	57
E.3.3.3	Changing the device into the Stopped Mode	57
E.3.4	LSS Configuration	58
E.3.4.1	Changing into the LSS Configuration Mode.....	58
E.3.4.2	Saving the parameters in the LSS Mode	58
E.3.4.3	Setting the bit rate	59
E.3.4.4	Setting the node-ID	59

E.2 Initial Operation

After starting the CANopen device is in the Pre-operational Mode (☞ E.3.3.2 and therefore doesn't send any position data. In order to achieve this, the device needs to be set into Operational Mode (☞ E.3.3.1) and if necessary the sending cycle of the position data has to be adjusted (☞ E.3.2.2).

E.3 Command Descriptions

In the following chapters the basics of CANopen communication are described. The message format is defined as follows:

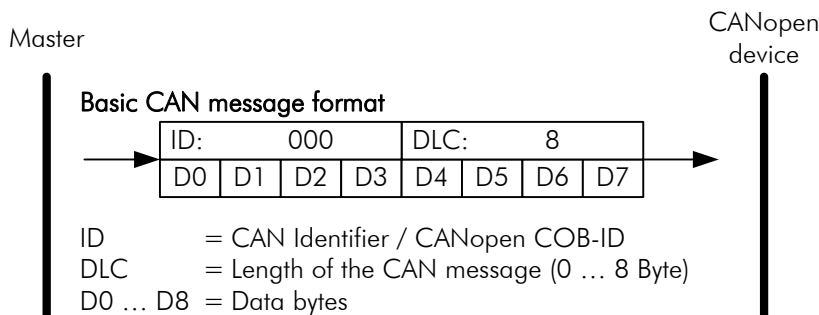

The arrow describes the data message transfer direction.

In CANopen data fields are always transferred in little endian format. This means if a 32-bit value is transferred in D4 ... D7, D4 contains the LSB and D7 contains the MSB.



NOTE!

The commands which are described in section E.3.1 and E.3.2 are only processed by the CANopen device in the Operational and Pre-Operational mode.

E.3.1 General Transfer of Service Data Objects (SDO)

E.3.1.1 Read object

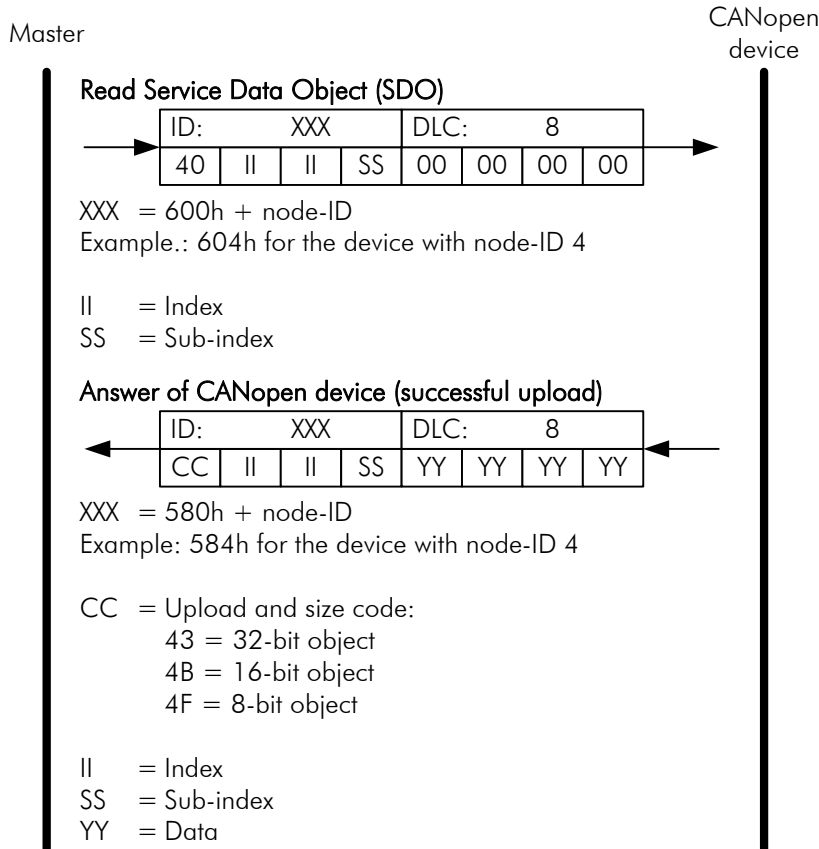

In case the transfer was not successful, the device responds with the abort transfer service (☞ E.3.1.3).

E.3.1.2 Write objects

The figure shows the CAN-Message who should be sent to the device and the following answer:

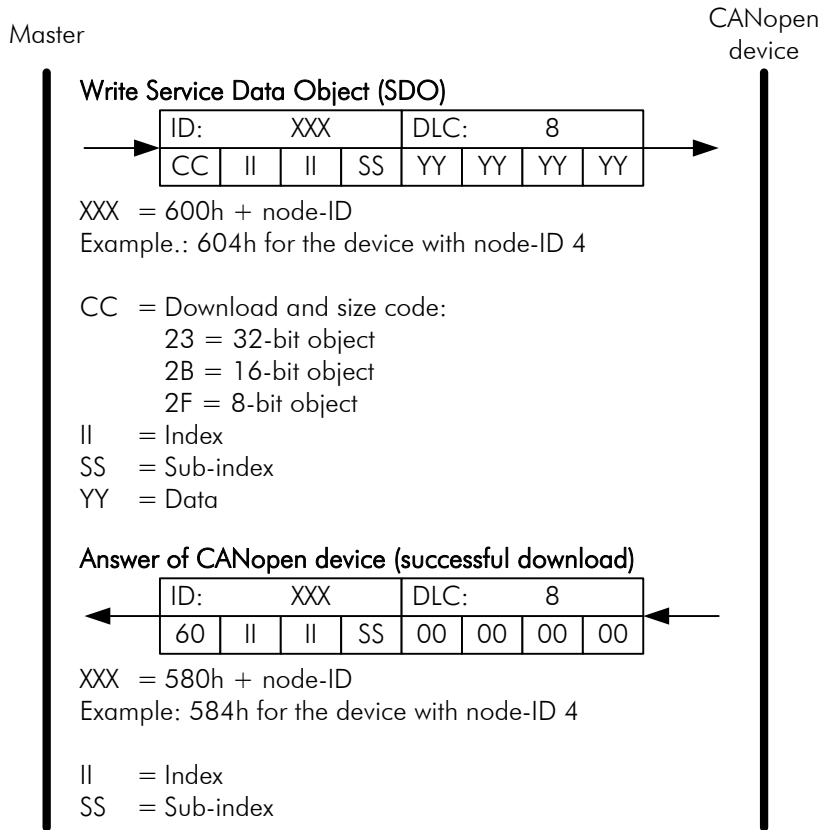

In case the transfer was not successful, the device responds with the abort transfer service (☞ E.3.1.3).

E.3.1.3 Abort Transfer

Fault messages can appear as an answer of the device generally during the upload and download.

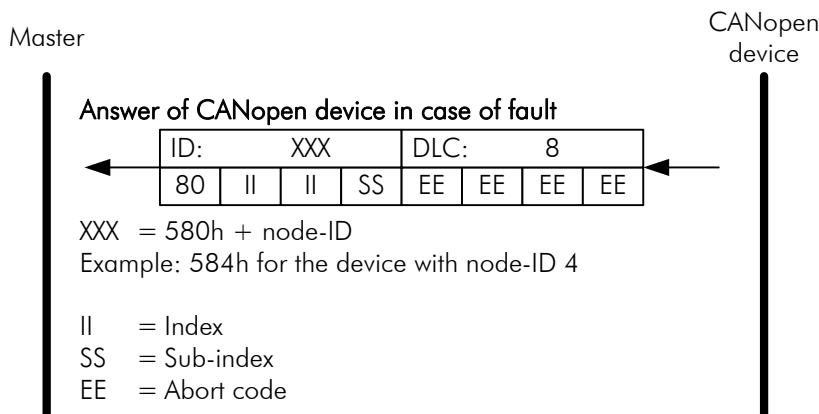

Abort code	Description
0601 0000 _h	Unsupported access to an object.
0601 0001 _h	Attempt to read a write only object.
0601 0002 _h	Attempt to write a read only object.
0602 0000 _h	Object does not exist in the object directory.
0609 0011 _h	Sub-index does not exist.
0609 0031 _h	Value of parameter written to high (download only).
0609 0032 _h	Value of parameter written to low (download only).
0800 0000 _h	General error.
0800 0024 _h	No data available.

The above list of the abort codes contains only the most important codes and is not final. Further codes are in the documentation of the respective ELGO product or in the general CANopen Spezifikation CiA 301 – „CANopen application layer and communication profile“, available from CAN in Automation, www.can-cia.org.

E.3.2 Regular mode

E.3.2.1 Setting the Heartbeat Cycle Duration

A CANopen device sends the heartbeat cyclically. This message communicates the current Operating Mode to the other bus sharing units.

1. Change into the Operational or Pre-operational Mode, if necessary
2. The following illustration shows the CAN-message, which should be transmitted to the CANopen device and the following answer.

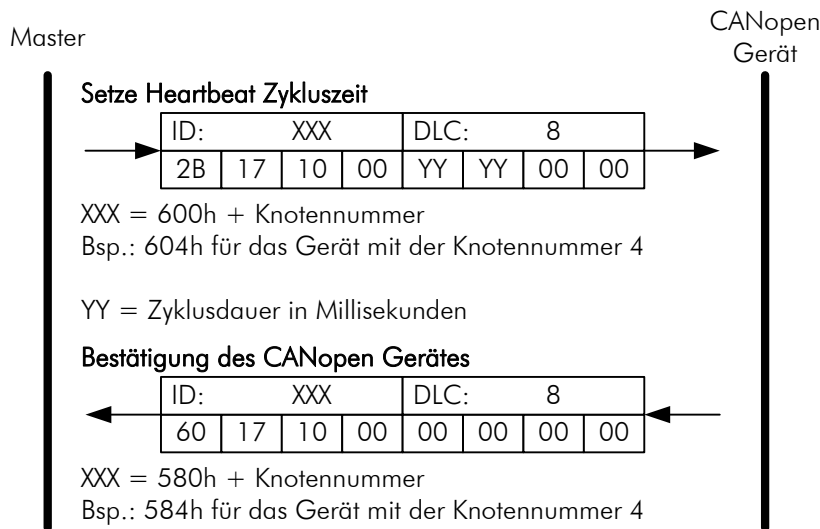

3. If the setting should be maintained in the case of a power failure, the changes have to be saved, as described in section E.3.2.3.

E.3.2.2 Setting the Sending Cycle for the position data

The position data are sent cyclically by the device, therefore the device has to be in the Operational Mode (E.3.3.1)

The settings of the cycle duration takes place in the device profile DS406 in the object 1800h, Sub-index 5 and for devices with DS407 profile in object 1906h, Sub-index 5.

1. Change into the Operational or Pre-operational Mode, if necessary.
2. The following figure shows the CAN-message, which should be transmitted to the CANopen device and the following answer.

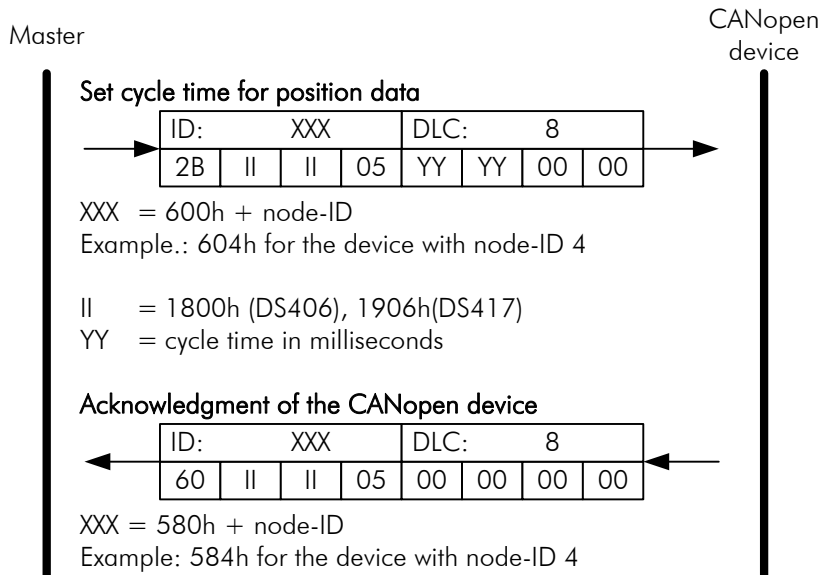

3. If the settings should be maintained in case of a power failure, the changes have to be saved, as described in section E.3.2.3

E.3.2.3 Saving the parameters

In the normal case the settings are lost at power failure. In order to avoid this, they need to be saved according to the following procedure.

1. Change into the Operational or Pre-operational Mode, if necessary.
2. The following figure shows the CAN-message, which should be transmitted to the CANopen device and the following answer.

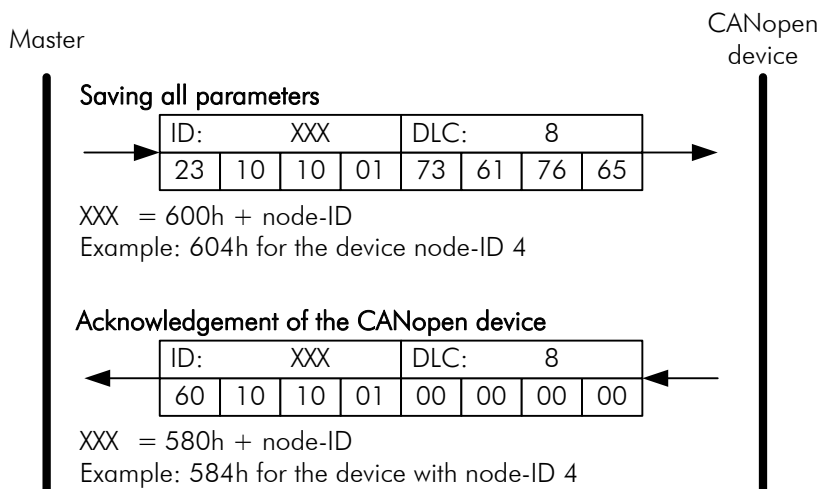

E.3.3 Changing the Operating Modes

E.3.3.1 Changing the device into the Operational Mode

In the Operational Mode the communication of the device is fully functional. The following CAN-message causes the change of all CANopen participants into the Operational Mode.

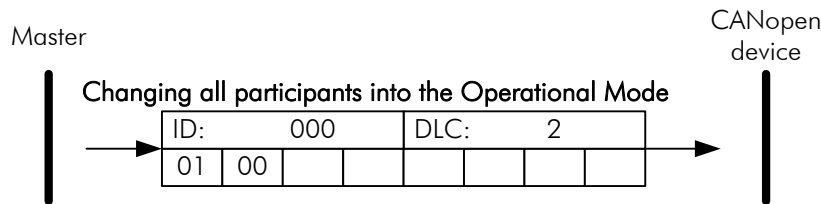

E.3.3.2 Changing the device into the Pre-operational Mode

In the Pre-operational Mode the communicating settings of the device are adjusted. The following CAN-message causes the change of all CANopen participants into the Pre-Operational Mode.

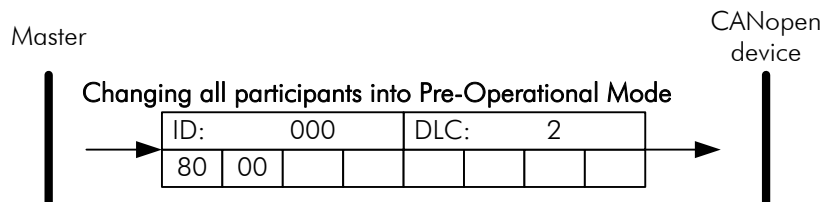

E.3.3.3 Changing the device into the Stopped Mode

Bus sharing units in the Stopped Mode are passive participants. In this mode all the communication is turned off, except the monitoring activity (e.g. heartbeat).

The following CAN-message causes the change of all CANopen participants into the Stopped Mode.

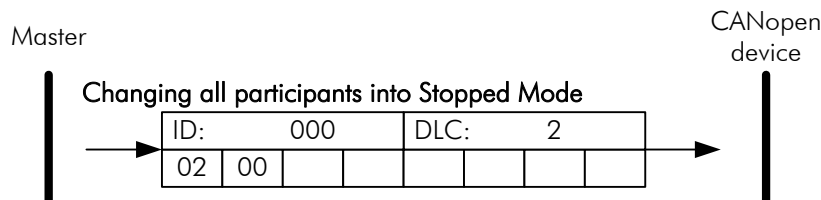

E.3.4 LSS Configuration

Basic settings like node-ID and bit rate have to be adjusted with the Layer Setting Services (LSS).

E.3.4.1 Changing into the LSS Configuration Mode

In order to be able to change the Parameter (node-ID, bit rate), the device has to be changed into the LSS Configuration Mode.

	<p>ATTENTION!</p> <p>With the following command all the bus sharing units which are in the Stopped Mode are changed into the LSS Configuration Mode. Use this command, if only one device is connected to the bus, because other devices could be affected in their function.</p>
---	--

The following CAN-message causes the change into the LSS Configuration Mode.

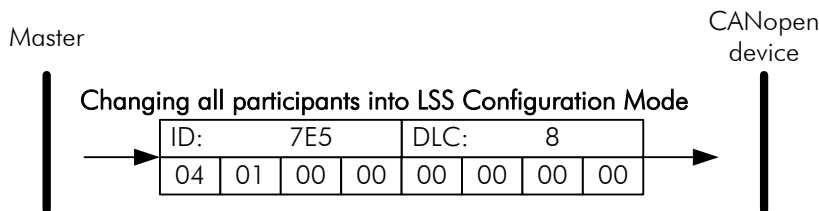

E.3.4.2 Saving the parameters in the LSS Mode

In order not to lose the changes in case of a power failure, they have to be saved in the non-volatile memory of the CANopen device.

The following figure shows the necessary message for this procedure.

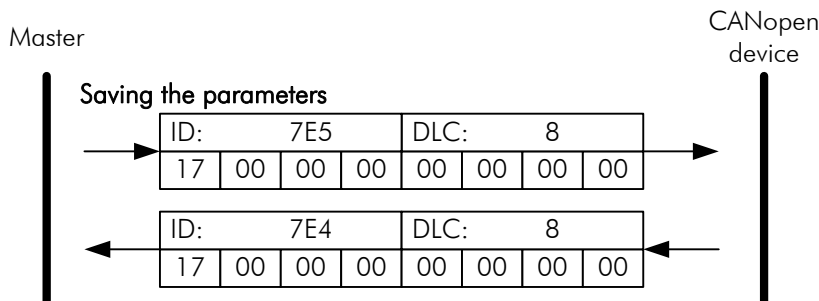

	<p>ATTENTION!</p> <p>During the saving procedure the device is not accessible over a period of a few milliseconds.</p>
---	---

E.3.4.3 Setting the bit rate

1. Change the device into the Stopped mode (☞ E.3.3.3)
2. Change the device into the LSS Configuration Mode (☞ E.3.4.1)
3. Change bit rate according to the following command:

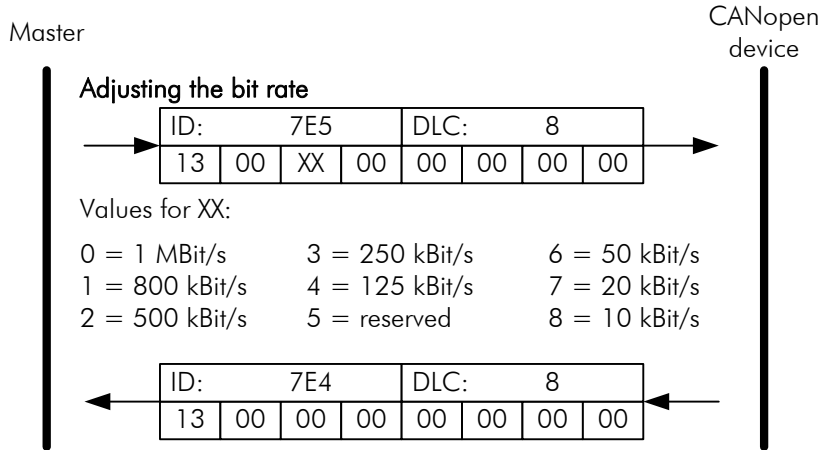

4. Save parameter as described in section E.3.4.2
5. Turn the device off and restart it again.

E.3.4.4 Setting the node-ID

1. Change the device into the Stopped Mode (☞ E.3.3.3)
2. Change the device into the LSS Configuration Mode (☞ E.3.4.1)
3. Change node-ID with the following message:

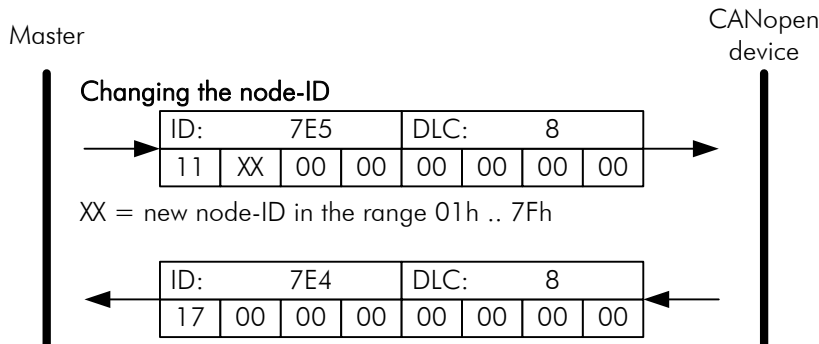

4. Save parameter as described in section E.3.4.2.
5. Turn the device off and restart it again.

Notes:

Document- No.: D-100968 / Rev. 3
Document- Name: LIMAXSAFE-006-CANopen-E_12-15
Subject to change - © 2015
ELGO Batscale AG

ELGO Batscale AG
Measure - Control - Position
Föhrenweg 20, FL-9496 Balzers
Fon.:+423 (0) 380 02 22, Fax.:+423 (0) 380 02 24
Internet: www.elgo.de, Mail: info@elgo.li

