

Operating Manual

SERIE LIMAX2M NEO

Magnetic Absolute Shaft Information System
(Translation of the original operating manual)



- Position measuring for lifting heights up to 130 meters
- Resolution up to 1000 μm (CANopen), 62.5 μm (SSI)
- Travel speed up to 4 m/s
- Insensitive to dirt, smoke and humidity
- Easy and flexible mounting
- No referencing necessary
- Magnetic tape may be installed vertically freely suspended or horizontally
- Wear-free, contactless and noiseless measuring principle

Publisher ELGO Batscale AG
Föhrenweg 20
FL-9496 Balzers

Technical Support  +49 (0) 7731 9339 – 0
 +49 (0) 7731 2 13 11
 support@elgo.de

Document- No. D-108108

Document - Name D-108108_35-23

Article Number 799001005

Document- Revision Rev. 1

Issue Date 2023-09-01

Copyright © 2023, ELGO Batscale AG

1 Contents

| | | |
|-----------|--|-----------|
| 1 | Contents | 3 |
| 2 | General | 5 |
| 2.1 | Information Operating Manual | 5 |
| 2.2 | Terms and Abbreviations | 5 |
| 2.3 | Explanation of Symbols | 6 |
| 2.4 | Statement of Warranties | 6 |
| 2.5 | Demounting and Disposal | 7 |
| 3 | Safety | 8 |
| 3.1 | General Causes of Risk..... | 8 |
| 3.2 | Personal Protective Equipment..... | 8 |
| 3.3 | Conventional Use | 9 |
| 4 | Transport and Storage | 10 |
| 4.1 | Safety Instructions for Transport, Unpacking and Loading | 10 |
| 4.2 | Handling of Packaging Material | 10 |
| 4.3 | Inspection of Transport | 10 |
| 4.4 | Storage | 10 |
| 5 | Product Features | 11 |
| 5.1 | Functional principle..... | 11 |
| 5.2 | Sensor Construction | 11 |
| 6 | Technical Data | 12 |
| 6.1 | Identification | 12 |
| 6.2 | Dimensions Sensor..... | 13 |
| 6.3 | Technical Data Sensor | 14 |
| 6.4 | Technical Data Magnetic Tape..... | 15 |
| 7 | Type Designation | 16 |
| 8 | Installation and First Start-Up..... | 17 |
| 8.1 | Operating Area | 17 |
| 8.2 | Description Mounting / Installation of the Sensor..... | 18 |
| 8.3 | Description installation / Mounting of the Magnetic Tape | 19 |
| 9 | Connections and Interfaces | 25 |
| 9.1 | LEDs (Operating Status and Notices)..... | 25 |
| 9.2 | CAN Interface | 26 |
| 9.3 | SSI Interface..... | 32 |
| 10 | Accessories | 33 |
| 11 | Disturbances | 34 |
| 11.1 | Fault Clearance..... | 34 |

| | | |
|-----------|-------------------------------------|-----------|
| 11.2 | Re-start after Fault Clearance..... | 35 |
| 12 | Maintenance | 36 |
| 13 | Cleaning..... | 36 |
| 14 | Index | 39 |

2 General

2.1 Information Operating Manual

This manual contains important information regarding the handling of the device.
For your own safety and operational safety, please observe all safety warnings and instructions.

Precondition for safe operation is the compliance with the specified safety and handling instructions.
Moreover, the existing local accident prevention regulations and the general safety rules at the site of operation have to be observed.

Please read the operating manual carefully before starting to work with the device!
It is part of the product and should be kept close to the device and accessible for the staff at any time. The illustrations in the manual are for better demonstration of the facts. They are not necessarily to scale and can slightly differ from the actual design.

2.2 Terms and Abbreviations

| Abbreviation/ Term | Explanation |
|-----------------------|-----------------------|
| LSB | Least Significant Bit |
| MSB | Most Significant Bit |

2.3 Explanation of Symbols

Special notes in this manual are characterized by symbols. The notes are introduced by signal words which express the magnitude of danger. Please follow this advice and act carefully in order to avoid accidents and damage and injuries.

Warning notes:

| | |
|--|--|
| | <p>DANGER! This symbol in connection with the signal word "Danger" indicates an immediate danger for the life and health of persons. Failure to heed these instructions can result in serious damage to health and even fatal injury.</p> |
| | <p>WARNING! This symbol in connection with the word „Warning“ means a possibly impending danger for the life and health of persons. Failure to heed these instructions can result in serious damage to health and even fatal injury.</p> |
| | <p>CAUTION! This symbol in connection with the signal word "Caution" indicates a possibly dangerous situation. Failure to heed these instructions can lead to injuries or damage of property.</p> |



Special safety instructions:

| | |
|--|---|
| | <p>DANGER! This symbol in connection with the signal word "Danger" indicates an immediate danger for the life and health of persons due to voltage. Failure to heed these instructions can result in serious damage to health and even fatal injury. The operations may only be carried out by a professional electrician.</p> |
|--|---|

Tips and recommendations:

| | |
|--|--|
| | <p>NOTE! ... points out useful tips and recommendations as well as information for an efficient and trouble-free operation.</p> |
|--|--|

References:

-  1.2) Marks a reference to chapter 1.2 of this manual.
-  DOC 3.4) Marks a reference to chapter 3.4 of the document *DOC*.

2.4 Statement of Warranties

The statement of warranties is enclosed separately in the sales documents.

Guarantee

The producer guarantees the functional capability of the process engineering and the selected parameters. The period of warranty is one year and begins with the date of delivery.

2.5 Demounting and Disposal

Unless acceptance and disposal of returned goods are agreed upon, demount the device considering the safety instructions of this manual and dispose it with respect to the environment.

Before demounting:

Disconnect the power supply and secure against re-start. Then disconnect the supply lines physically and discharge remaining energy. Remove operational supplies and other material.

Disposal:

Recycle the decomposed elements:

- Metal components in scrap metal
- Electronic components in electronic scrap
- Recycle plastic components
- Dispose the remaining components according to their material consistence

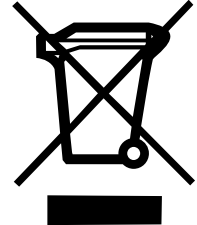

CAUTION!

Wrong disposal causes environmental damages!
Electronic scrap, electronic components, lubricants and other auxiliary materials are subject to special refuse and can only be disposed by authorized specialists!

Local authorities and waste management facilities provide information about environmentally sound disposal.

3 Safety

| | |
|---|---|
|  | <p>CAUTION! Please read the operating manual carefully, before using the device! Observe the installation instructions! Only start up the device if you have understood the operating manual.</p> <p>The operating company is obliged to take appropriate safety measure. The initial operation may only be performed by qualified and trained staff.</p> <p>Selection and installation of the devices as well as their embedding into the controlling system require qualified knowledge of the applicable laws and normative requirements on the part of the machine manufacturer.</p> |
|---|---|

3.1 General Causes of Risk

This chapter gives an overview of all important safety aspects to guarantee an optimal protection of employees and a safe and trouble-free operation.
 Non-observance of the instructions mentioned in this operating manual can result in hazardous situations.



3.2 Personal Protective Equipment

Employees have to wear protective clothing during the installation of the device to minimize danger of health.

Therefore:

Change into protective clothing before performing the works and wear them throughout the process.
 Additionally observe the labels regarding protective clothing in the operating area.

Protective clothing:

| | |
|---|---|
|  | <p>PROTECTIVE CLOTHING ... is close-fitting working clothing with light tear strength, tight sleeves and without distant parts. It serves preliminarily for protection against being gripped by flexible machine parts. Do not wear rings, necklaces or other jewellery.</p> |
|  | <p>PROTECTIVE GLOVES ... for protecting the hands against abrasion, wear and other injury of the skin.</p> |
|  | <p>PROTECTIVE HELMET ... for protection against injuries of the head.</p> |

3.3 Conventional Use

The product described in this manual is designed to detect the position of the elevator car in the shaft with high precision. It is the responsibility of the manufacturer of a machine or installation to ensure the proper operation of the system. The ELGO-device is conceived only for the intended use described in this manual.

The LIMAX2M NEO - ELGO- length measuring system serves only to measure lengths.

**CAUTION!**

Danger through non-conventional use!

Non-intended use and non-observance of this operating manual can lead to dangerous situations.

Therefore:

- Only use the device as described
- Strictly follow the instructions of this manual

Avoid in particular:

- Remodelling, refitting or changing of the construction or single components with the intention to alter the functionality or scope of the device.

Claims resulting from damages due to non-conventional use are not possible.
Only the operator is liable for damages caused by non-conventional use.

4 Transport and Storage

4.1 Safety Instructions for Transport, Unpacking and Loading

**CAUTION!**

Transport the package (box, palette etc.) professionally.
Do not throw, hit or fold it.

4.2 Handling of Packaging Material

Notes for proper disposal: ☞ 2.5

4.3 Inspection of Transport

Check the delivery immediately after the receipt for completeness and transport damage.
In case of externally recognizable transport damages:

- Do not accept the delivery or only accept under reserve.
- Note the extent of damages on the transportation documents or delivery note.
- File complaint immediately.

**NOTE!**

Claim any damage immediately after recognizing it. The claims for damage must be filed in the lawful reclaim periods.

4.4 Storage

Store the device only under the following conditions:

- Do not store outside
- Keep dry and dust-free
- Do not expose to aggressive media
- Protect from direct sun light
- Avoid mechanical shocks
- Storage temperature (☞ 6 Technical Data) needs to be observed
- Relative humidity (☞ 6 Technical Data) must not be exceeded
- Inspect packages regularly if stored for an extensive period of time (>3 months)

5 Product Features

The absolute shaft information system LIMAX2M NEO with its significant advantages is a particularly affordable, non-sensitive and easy-to-install alternative to conventional shaft information systems. Due to the absolute measurement principle, referencing is not required after commissioning.

Compared to other shaft information systems, LIMAX2M NEO is characterized by an extraordinarily low price. LIMAX2M NEO is able to cover lifting heights up to 130 meters and speeds up to 4 m/s. The standard interfaces are CAN or SSI. We also provide customized solutions on request.

This measuring system provides smallest sensor of the entire LIMAX series. With these small space requirements, LIMAX2M NEO is ideal for remodelling and modernization.

A simple and flexible mounting ensures quick installation or replacement of the measuring system.

Features:

- Robust measuring principle to dirt, smoke and humidity
- Easy and flexible mounting
- No reference necessary
- Wear-free, contactless and noiseless measuring principle

5.1 Functional principle

The tape carries the unique positioning information as a magnetic code. It is installed free hanging in the elevator shaft by use of a mounting kit. The sensor head is mounted to the elevator car. While the actual measurement is contactless the tape must be kept within a maximum distance to the sensor head. Therefore, the tape is guided along the sensor by use of the polymer tape guide which is an integral component of the sensor head.

The magnetic measurement principle is extremely robust. Dust, dirt and humidity do not affect the measurement in any way. Also, smoke and even higher temperatures have no influence on the measuring quality. Therefore, LIMAX2M NEO is particularly suited for application in fire fighter elevators. Also is the tape robust enough to withstand the sometimes-harsh conditions in elevator shafts.

5.2 Sensor Construction

The LIMAX2M NEO sensor consists of the following components:

- Sensor housing with integrated signal LEDs for signaling various states.
- Connector for power supply and communication with the lift control.
- Guide rail with plastic underlay (keeps the magnetic tape at a defined distance from the sensor).
- Holding plate for mechanical fixation of the polymer guide rail.

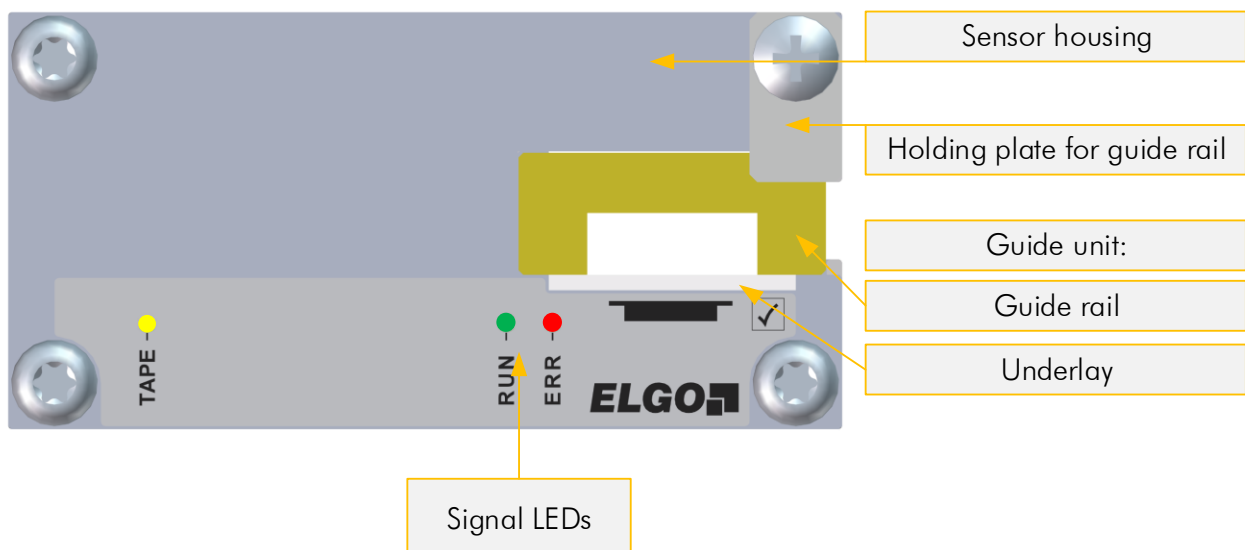

Figure 1: Sensor Assembly

6 Technical Data

6.1 Identification

The type label serves for the identification of the unit. It is located on the housing of the sensor and gives the exact type designation (=order reference, see type designation, chapter 7) with the corresponding part number. Furthermore, the type label contains a unique, traceable device number, the production date as well as the hardware and software versions.

When corresponding with ELGO always indicate this data.



Fig. 1: Type label for identification of the sensor

6.2 Dimensions Sensor

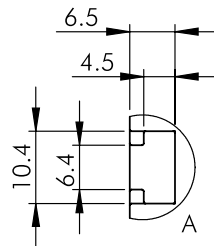
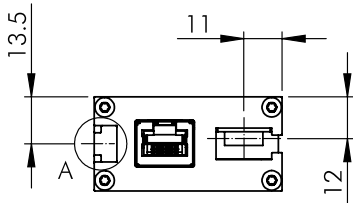
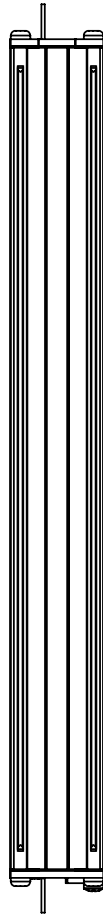
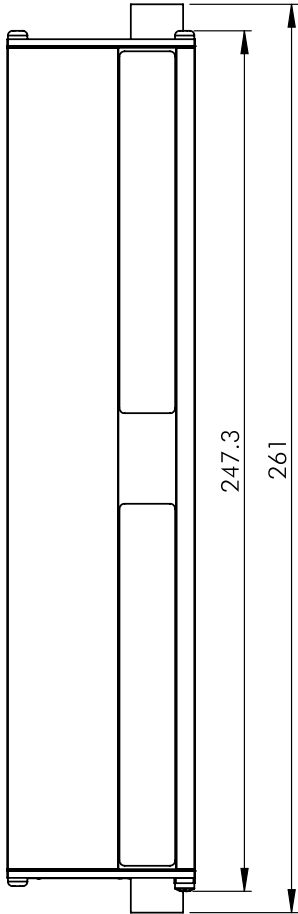
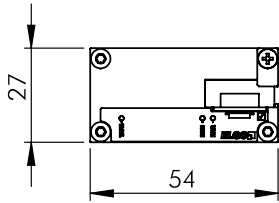

6.3 Technical Data Sensor

LIMAX2M NEO (Standard version)

Mechanical Data

| | |
|---------------------------------------|--|
| Measuring principle: | absolute |
| Measurement: | linear |
| Maximum measuring length | 130 m |
| Speed: | max. 4 m/s |
| Resolution: | ☞ 7 Type Designation |
| Repeat accuracy: | +/- 1 Increment |
| System accuracy at 20°C: | +/- (1000 μm + 50 μm x L[m]) L = measuring length in meter |
| Distance from sensor to magnetic tape | 4 mm |
| Dimensions (without cable): | L x B x H = 247 x 54 x 27 mm |
| Housing material: | aluminium |
| Connection: | RJ45 socket Round plug M12 (5-pole; 8-pole depending on the interface) (more options ☞ 7 Type Designation) |
| Sensor cable: | Available as an accessory |
| Weight: | approx. 320 g without cable (cable approx. 60 g/m) |

Magnetic tape

| | |
|-----------------|--------------------------|
| Necessary type: | AB20-80-10-1-R-D-15-BK80 |
|-----------------|--------------------------|

Conditions

| | |
|----------------------------------|---|
| Storage temperature: | -20 °C ... +85 °C |
| Operation temperature: | -10 °C ... +70 °C (-25 °C ... +85 °C upon request) |
| Humidity: | max. 95 %, non-condensing |
| Protection class: | IP53 (RJ45 – version, according to EN 60529) IP55 (M12M – version, according to EN 60529) IP67 (M12M – version, pressure compensation element with membrane, according to EN 60529) |
| Operation height: | max. 3000 absolute altitude |
| EMC transient emission/immunity: | according to EN 12015 / EN 12016 |
| Vibration/shock resistance: | according to EN 60068-2-6 / EN60068-2-27, EN60068-2-29 |

Electrical Data

| | |
|--|--|
| Supply voltage: | + 10 ... 30 VDC (stabilized) |
| Residual ripple: | < 200 mVpp |
| Reverse voltage protection: | integrated |
| Power input: | max. 200 mA @ 24 VDC |
| Interfaces: | CANopen (CiA 406 or CiA 417), SSI gray- and binary code |
| Protection of the outputs/ interfaces: | not short-circuit-proof |

6.4 Technical Data Magnetic Tape

The magnetic tape consists of two components:

- The actual magnetic tape which carries the position information
- A mechanical stainless steel back iron

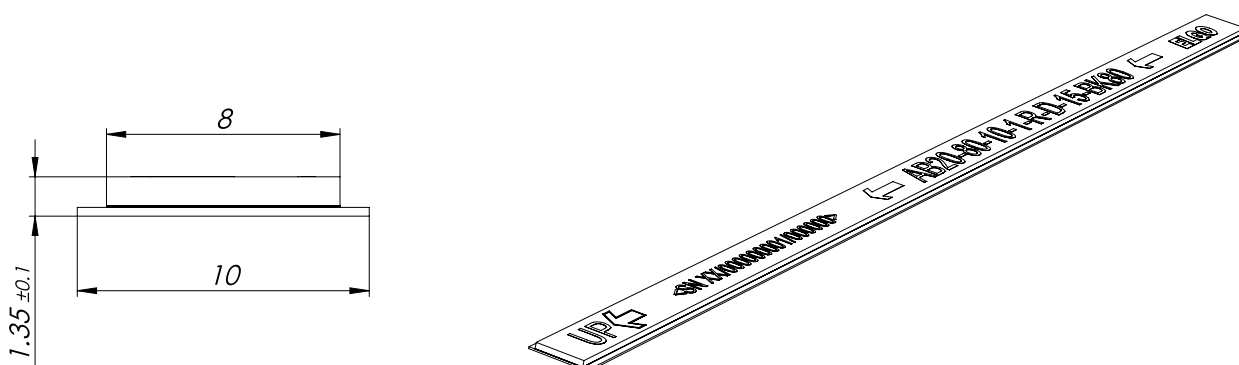

TEMPLATE Magnetic Tape AB20-80-10-1-R-D-15-BK80

| | |
|-------------------------------|---|
| Coding: | absolute, ELGO 15 Bit |
| Basic pole pitch: | 8 mm (+/- 0,05 mm) |
| Maximum tape length: | 262 m per role |
| Maximum length error: | +/- 100 µm/m |
| Operation temperature: | -20 °C ... +70 °C |
| Storage temperature: | short-run: -40 °C ... +85 °C medium-run: -20 °C ... +70 °C |
| Relative humidity: | max. 95 %, non-condensing |
| Dimensions: | B / B1 x H = 10 mm (+/- 0,1) / 8 mm (+/- 0,2) x 1,35 mm (+/- 0,1) |
| Linear expansion coefficient: | $\alpha \approx 16 \times 10^{-6} \text{ 1/K}$ |
| Linear thermal expansion: | $\Delta L[\text{m}] = L[\text{m}] \times \alpha[1/\text{K}] \times \Delta \vartheta[\text{K}]$ (L = tape length in meter, $\Delta \vartheta$ = relative change in temperature) |
| Bend radius: | min. 50 mm |
| Weight of magnetic tape | ca. 52 g/m |
| Tape imprint | ELGO Standard, colour black, front size $\geq 5 \text{ mm}$ |
| External magnet: | External magnetic fields shall not exceed 64 mT (640 Oe; 52 kA/m), otherwise the magnetic coding will be damaged or destroyed. |
| Protection: | Back iron stainless steel |

7 Type Designation

Type designation: **LIMAX2M** - **X0** - **BBB** - **1000** - **CO0T** - **M12M**

Version: _____

10 = Standard ELGO Batscale
20 = Standard ELGO Electronic

Signal cable length: _____

CON = without cable (standard)

Resolution: _____

62N5 = 62.5 μm (SSI – Interface)
0500 = 500 μm (CAN – Interface)
1000 = 1000 μm (CAN – Interface)

Interface*: _____

COX = CANopen [special protocol separately defined by version number]

CO0 = CANopen [Encoder Profil CiA 406]

CO1 = CANopen [Elevator Profil CiA 417]

SSGX = SSI [special protocol separately defined by version number]

SSG0 = SSI [25 Bit gray code / position]

*other on request

NOTE:

1. assembly CAN-termination resistor selectable
2. SSI-Interface is basically terminated

| CAN- Interface | Without galvanic isolation | With galvanic isolation (G) |
|---------------------------|----------------------------|-----------------------------|
| With termination 120R (T) | CO0T (Standard) | CO0TG |
| Without termination | CO0 | CO0G |
| With termination 120R (T) | CO1T (Standard) | CO1TG |
| Without termination | CO1 | CO1G |

Connection options: _____

M12M = M12F5 = 5-pin M12-Round plug [CAN] (IP55)

M12F8 = 8-pin M12-Round plug [SSI] (IP55)

RJ45 = RJ45 socket (IP53)

Additional information:

CANopen CiA417 (IP53) = CANopen with lift profile CiA 417 and protection class IP53*
 CANopen CiA406 (IP53) = CANopen with encoder profile CiA 406 and protection class IP53*
 SSI gray (IP53) = SSI with gray code and protection class IP53*
 SSI binary (IP53) = SSI with binär code and protection class IP53*

 SSI gray (IP55) = SSI with gray code and protection class IP55**
 SSI binary (IP55) = SSI with binary code and protection class IP55**
 CANopen CiA417 (IP55) = CANopen with lift profile CiA 417 and protection class IP55**
 CANopen CiA406 (IP55) = CANopen with encoder profile CiA 406 and protection class IP55**

* Only available with connection - option RJ45





**Only available with connection - option M12M

8 Installation and First Start-Up

| | |
|---|---|
|  | <p>CAUTION Please read the operating manual carefully before using the device! Strictly observe the Installation instructions! In case of damage caused by failure to observe this operating manual, the warranty expires.</p> <p>ELGO is not liable for any secondary damage and for damage to persons, property or assets.</p> <p>Der Betreiber ist dazu verpflichtet, geeignete sicherheitsrelevante Maßnahmen zu ergreifen und durchzuführen.</p> <p>The operator is obliged to take appropriate safety measures. The first start-up may only be performed by staff that has been trained and authorized by the operator.</p> |
|---|---|

8.1 Operating Area

| | |
|---|---|
|  | <p>WARNING! Do not use the device in explosive or corrosive environments! The device must not be installed close to sources of strong inductive or capacitive interference or strong electrostatic fields!</p> |
|---|---|

| | |
|---|---|
|  | <p>CAUTION! The electrical connections must be made by suitably qualified personnel in accordance with local regulations.</p> |
|  | <p>The device may be designed for switchboard mounting. During work on the switchboard, all components must be de-energized if there is a danger of touching the energized parts! (protection against contacts)</p> |
|  | <p>Wiring works may only be performed in the de-energized state!</p> |
|  | <p>Thin cable strands have to be equipped with end sleeves!</p> <p>Before switching on the device, connections and plug connectors have to be checked!</p> |
|  | <p>The device must be mounted in a way that it is protected against harmful environmental influences such as splashing water, solvents, vibration, shock and severe pollution and the operating temperature must not be exceeded.</p> |

8.2 Description Mounting / Installation of the Sensor

8.2.1 Installation Principle

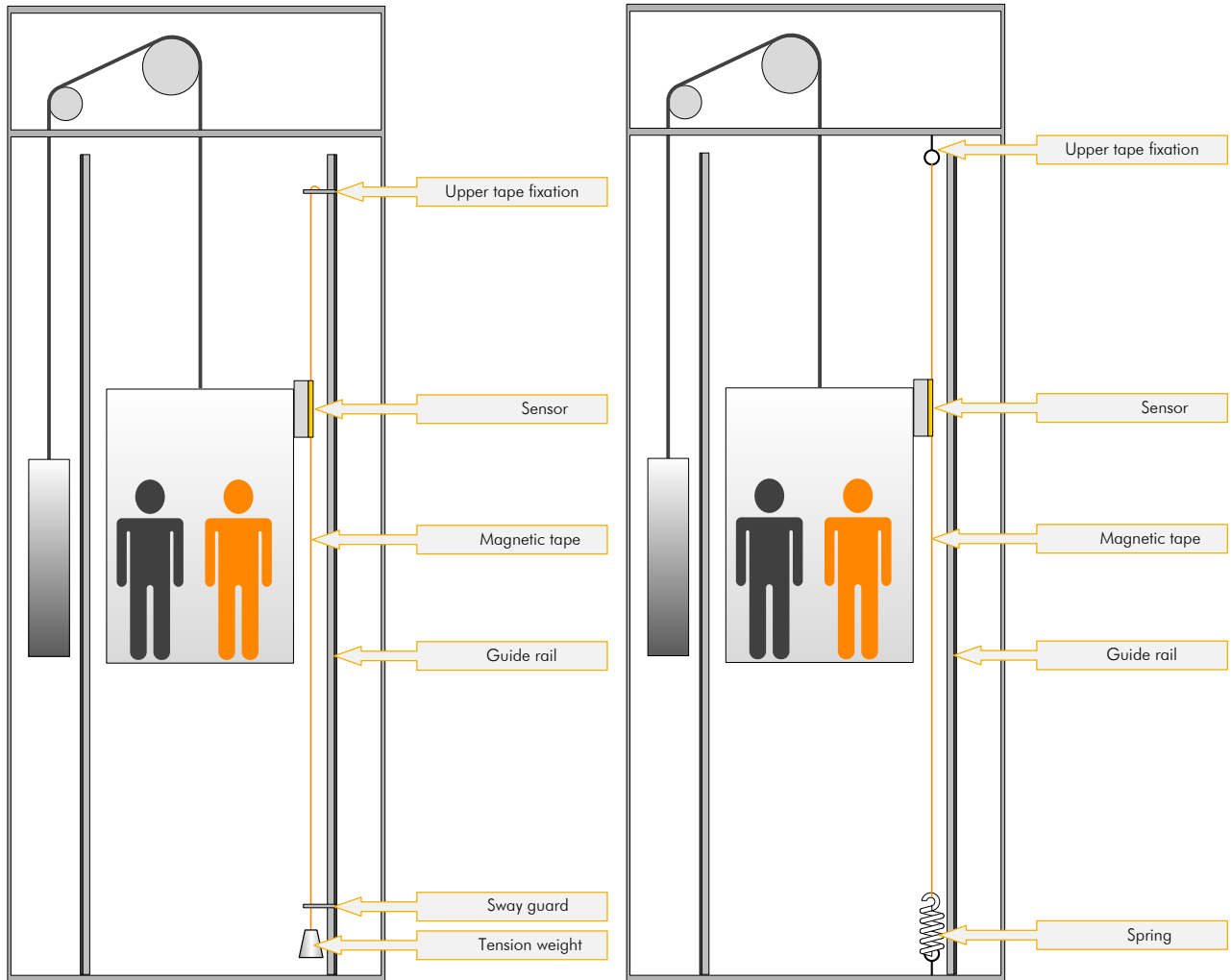

Figure 2: Installation with tension weight

Figure 3: Installation with spring

LIMAX2M NEO can be installed at any position in the shaft, depending on space situation and layout of the particular elevator installation.

The magnetic tape is installed freely suspended in the shaft. It can be fixed with the RMS mounting kit (available as option) on the guide rail. Alternatively fixation in the shaft head is either on beams or directly bolted into the ceiling. The necessary tension in the tape is provided by a tension weight of about 5kg. A sway guard at the bottom is recommended. This will keep the tape from swaying in an uncontrolled manner which may cause damage to the tape or other components in the shaft. Alternatively the magnetic tape can be tensioned by a spring.

The sensor head can be mounted onto the car body or car frame – again depending on the specific conditions of the elevator.

8.2.1 Installation of the Sensor

The sensor is fixated on the cabin or on the car frame. The mounting position is basically determined by the condition.

The integrated mounting notch on the housing of the sensor head allow for a very simple and self-explanatory installation from one side. You can either use M6 hexagon head screws (DIN 933) or M6 square nuts (DIN 562), to mount the system at the desired position.

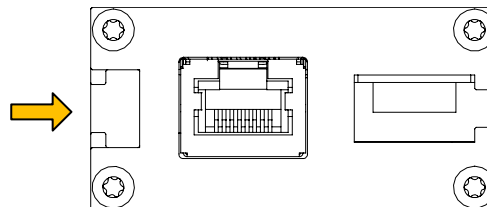

Figure 4: Mounting groove on the sensor

| | |
|--|---|
| | <p>NOTE During installation of the magnetic tape in the sensor, pay attention to the marks on the magnetic tape and on the sensor head.</p> <p>Wrong orientation of tape vs. Sensor head will yield incorrect position readings! The arrows printed on the magnetic tape and sensor head point in positive counting direction (in the direction of the shaft head)!</p> |
|--|---|

8.3 Description installation / Mounting of the Magnetic Tape

| | |
|--|--|
| | <p>NOTE External Magnetic Fields The influence of the magnetic tape by magnetic fields must be avoided! The magnetic tape must not come into direct contact with other magnetic fields (e.g. permanent magnets, magnetic clamps, electromagnets, magnetic stands)! This may cause irreparable damage, which will compromise the measuring accuracy or even the functioning.</p> |
|--|--|

8.3.1 General Information

The technology has proven to be highly robust. LIMAX2M NEO will work under the most adverse environmental conditions. Extreme temperatures, high moisture and excessive soiling will not alter the information coded onto the tape nor will these conditions affect reading precision of the sensor. Even weak magnetic fields such as they are generated by door magnets can be tolerated.

If some basic rules and guidelines are followed LIMAX2M NEO systems require a minimum amount of installation and maintenance effort while offering maximum lifetime.

One important issue to consider is the protection of the magnet tape against mechanical wear. The LIMAX2M NEO tape consists of two components:

- The magnetic tape which actually carries the position information
- A protective steel tape which gives the mechanical properties

8.3.2 Installation Concept

8.3.2.1 Basic principle for the mounting

| | |
|---|--|
|  | <p>NOTE! The magnetic tape itself is not designed to withstand excessive mechanical wear. It is therefore important to ensure that the system is installed such that the mechanical contact between tape and sensor head is mainly between the steel tape and the polymer sensor guide. These two materials have been specifically paired for this application.</p> |
|---|--|

Avoiding contact between the magnetic side and the sensor could be achieved with a perfectly perpendicular installation of the band. Yet, in reality this is not practicable. It is therefore preferable to install the tape with a horizontal offset from the sensor. During operation this method will result in a forced contact between the steel side of the band and the polymer guide of the sensor which guarantees an optimal operation of the system.

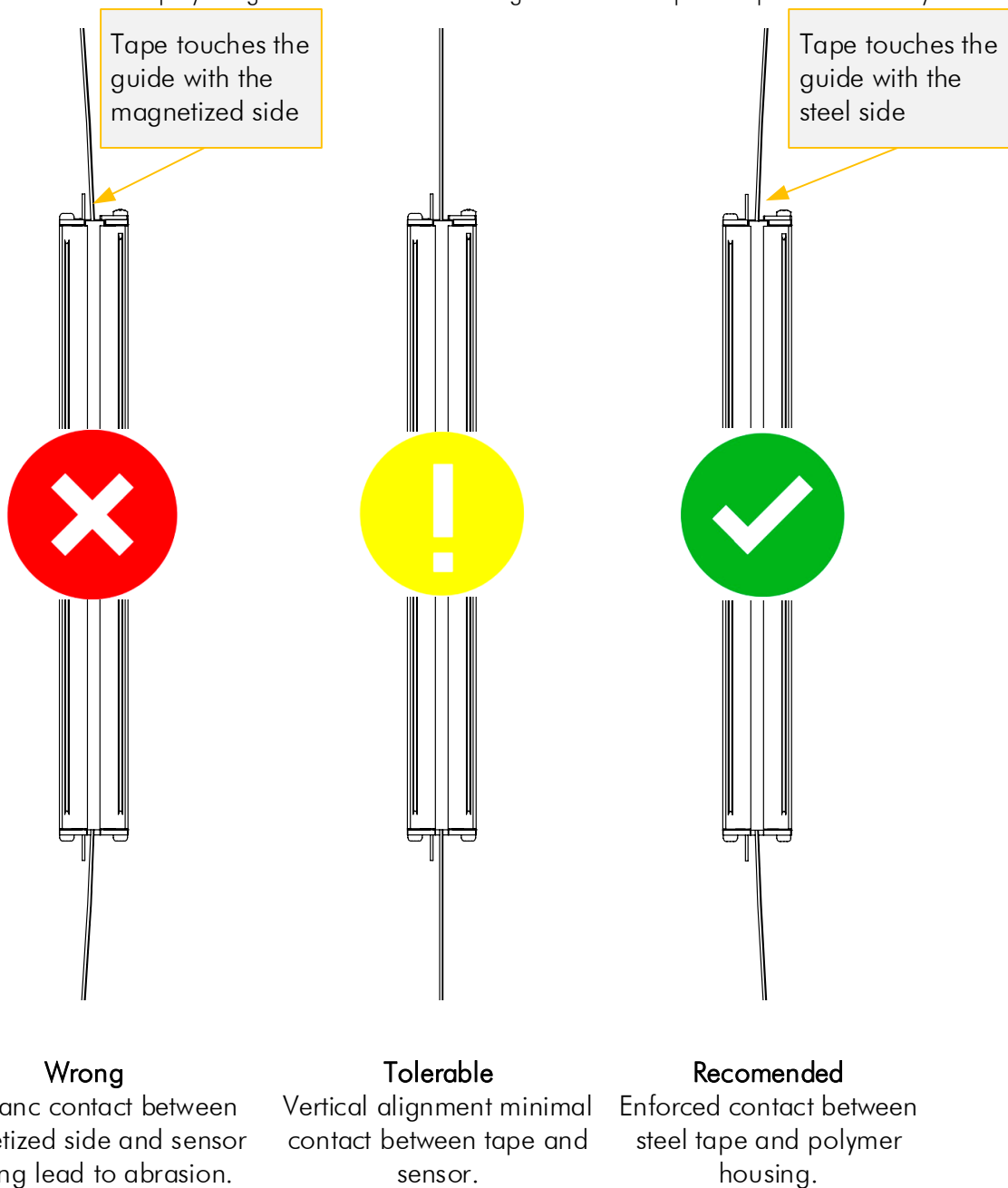

Figure 5: Assessment of the pretention of the magnetic tape

8.3.3 Installation Procedure

1. Attach the top end of the tape in the shaft head. Ideally use an ELGO Mounting Kit. Check for correct orientation of the tape. The arrows on the magnetic side must point in upward direction.



Figure 6: Correct orientation of the magnetic tape

2. The magnetic side of the tape must face the sensor body. In most situations this means that the steel side points to the shaft wall.
3. Drive down the shaft with inspection speed and unroll the tape. The ELGO tape packaging system has been specifically designed for this purpose. The tape can be unwound directly from the box without opening.
4. Attach the tension weight (about 7.5 kg) at the bottom end of the tape in the shaft. Secure the tape with a sway guard. Pay attention to a proper vertical mounting of the tape. If you use dowels to fix the tape in the shaft, tighten the spring such, that the according tractions results to minimum 7.5 kg. When using the ELGO Mounting Kit RMS/RMS90 this is equivalent to a spring elongation of about 90mm. Note that slightly higher tensile forces are never a problem, but avoid under-tensioning. In higher buildings it may even be preferable to slightly increase the tension in order to prevent flapping of the tape during operation. However, if correctly installed tensile forces of more than 10 kg should never be necessary.
5. Drive the car to the middle of the shaft.
6. Attach the sensor to the car. The side with the cable outlet and the LED's must face upward.
7. Adjust the sensor using the tape as a reference. First, align sensor and magnet band on their centerline.

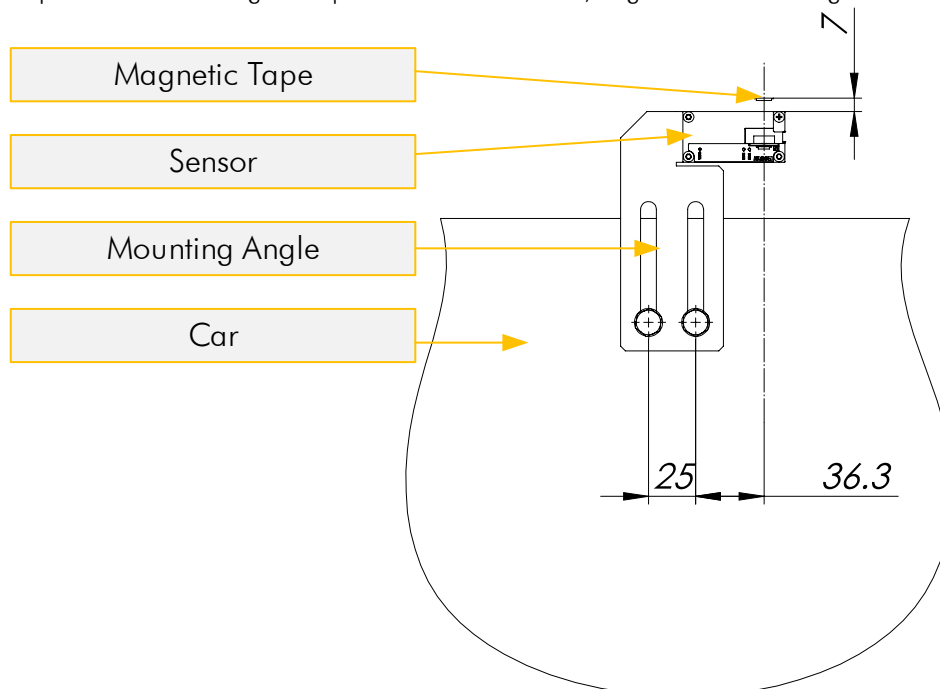

Figure 7: Distance and orientation of the magnetic tape in relation to the sensor

8. Adjust now the distance between sensor and tape. Up to a travel height of 50m we recommend an offset of at least 7 mm. This will ensure steady contact between steel side of the band and the polymer guide of the sensor. This level can be increased later, if it turns out that the band still rubbing with the magnetic side on the sensor. In higher installations this distance may be increased by the initial assembly up to 5 cm. Pay attention to a perpendicular alignment of the sensor. Misalignment will lead to increased wear.

9. Pass the tape through the sensor. Loosen the splint-pin and release the polymer guide. Insert the tape and re-attach the guide with the tape in its position.
10. Pay attention that the pad does not slip after removal of the polymer guide from the aluminium guide out and drops down in the shaft.
11. Check for proper alignment of band vs. sensor. Any angular offset should be corrected.

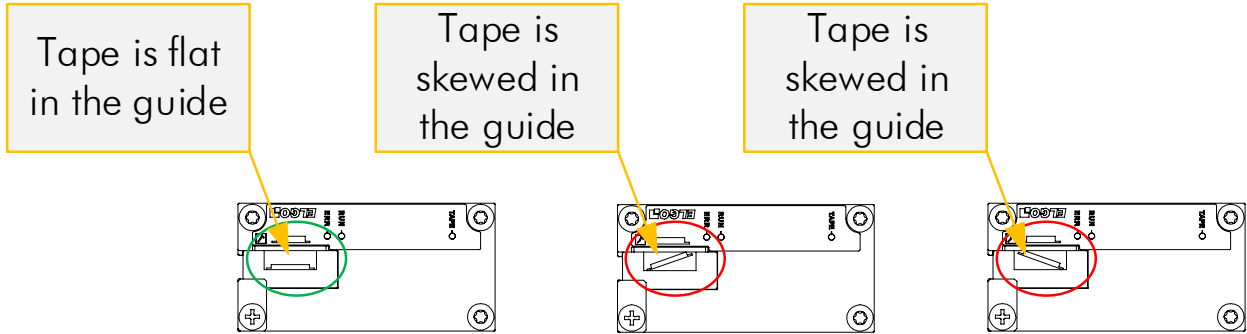

Figure 8: Assessment of the guiding rail of the tape in the sensor - twisted magnetic tape

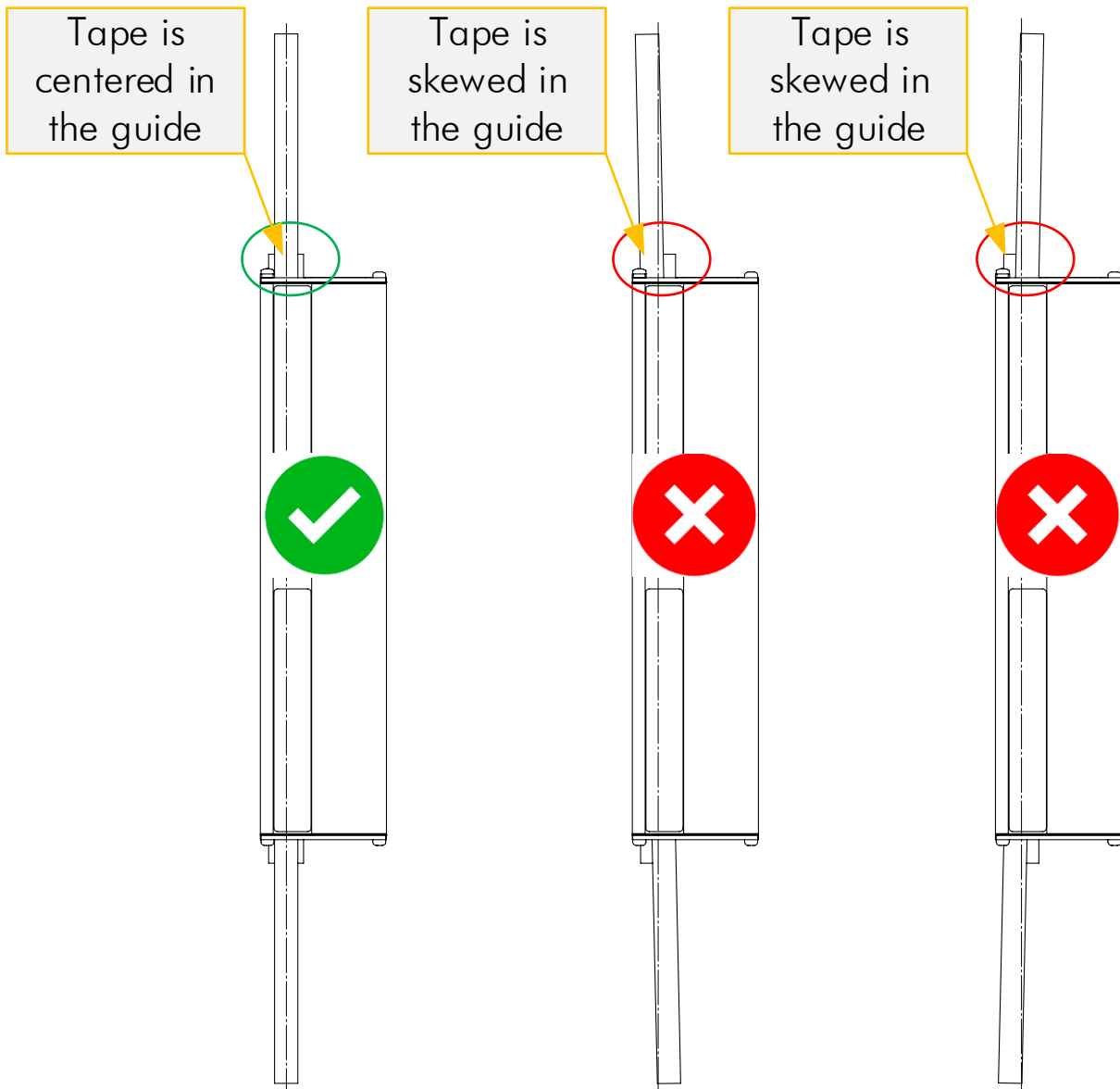

Figure 9: Assessment of the guiding rail of the tape in the sensor - skewed mounting of the magnetic tape

12. IMPORTANT: Installation Check!

Values for tape tension and offset between tape and sensor are guidelines based on experience. But in any case, a proper check after installation is mandatory. **It must absolutely be avoided that the magnetic side constantly grinds on the sensor body during operation.**

Run an inspection trip along the complete shaft. Observe the system and pay attention to the respective positions of band and sensor. You have achieved an optimal installation if the steel side of the tape is constantly pressed slightly against the polymer guide of the sensor. At some points in the shaft also double-check on the bottom side of the sensor. If the sensor is tilted it may look good on top but the tape can still grind along the bottom edge of the sensor.

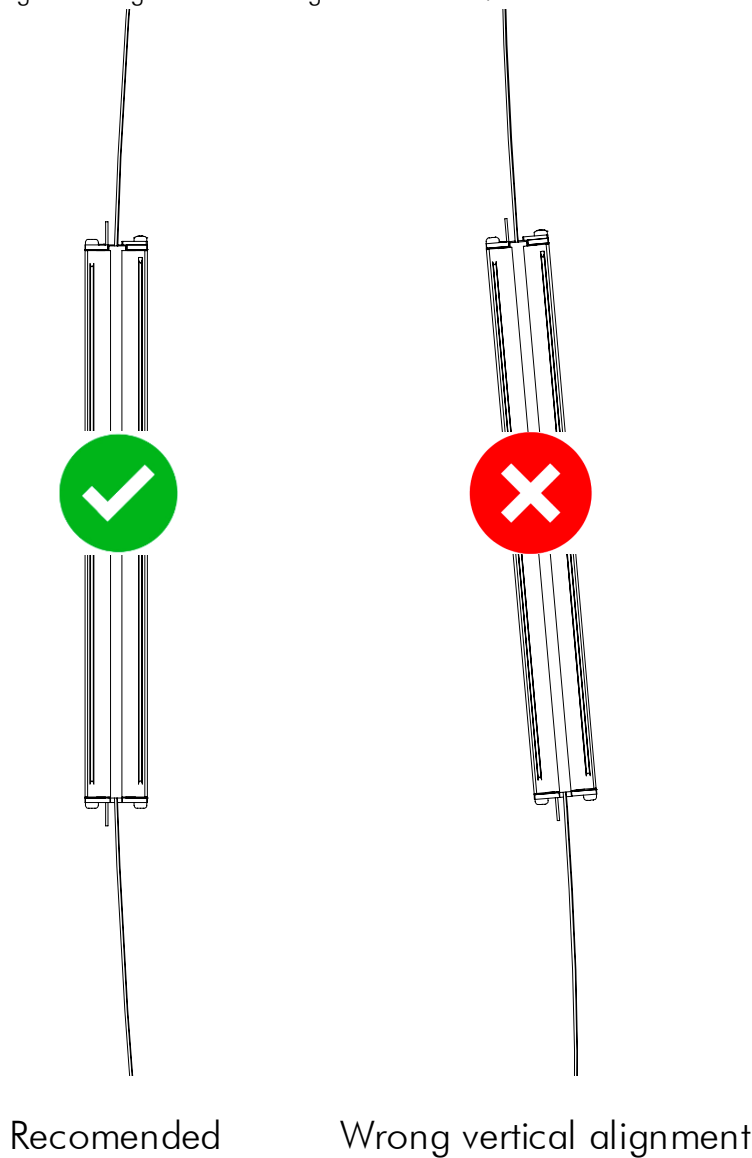





Figure 10: Assessment of the vertical alignment of the sensor

13. If the installations check reveals that the tape slides on magnetic side, start to increase the offset between sensor and tape. Values of up to 5 cm are acceptable. If this measure does not solve the problem it is very likely that the tape is not plumb in the shaft. This is easy to check for, provided your elevator control allows for inspection trips without the absolute position signal: Just take the tape out of the sensor and run an inspection trip along the shaft. Observe the distance between sensor and tape along the travel. Misalignments will become obvious. Also ensure that the tension on the tape is sufficient. A loosely tensioned tape will hinder proper guiding.
14. After completion of the installation clean the tape. Beginning at the top of the shaft drive down the complete travel distance pulling the magnet tape through a dry clean cloth.

| | |
|---|---|
|  | <p>NOTE!</p> <p>Be specifically alert if steel construction work is taking place in the shaft. Steel particles released by grinding, welding or such work will adhere to the magnetic tape. The tape is insensitive to fine metal dust. However, <u>coarser</u> metal chips can cause problems. Clean this debris off instantly. Repeat the cleaning process before putting the elevator into operation after complete installation.</p> |
|  | <p>DO NOT USE A MAGNET FOR CLEANING!</p> <p><u>Never</u> use a magnet to remove metal chips from the magnetic tape. This will destroy the magnetic code and thus the magnetic tape.</p> |
|  | <p>PROTECTIVE GLOVES!</p> <p>Always wear protective gloves when cleaning the magnetic tape.</p> |

9 Connections and Interfaces

9.1 LEDs (Operating Status and Notices)

The LED's located on the front serve for monitoring of operating conditions.

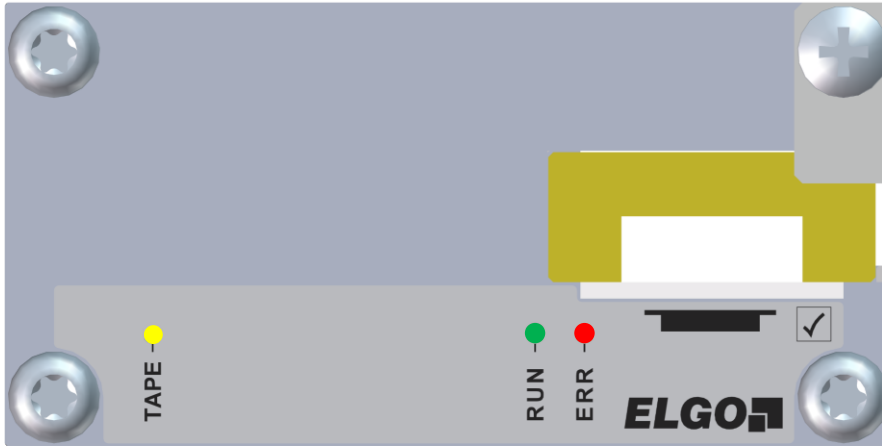

Figure 11: LED signals on the upper side of the sensor

RUN GREEN

| | | |
|--------------------|---|--|
| For CANopen device | = | RUN-LED according to DR 303-3 |
| Other devices | = | Interface state, flashes during active communication |

ERR RED

| | | |
|--------------------|---|--|
| For CANopen device | = | ERR-LED according to DR303-3 or error message* |
| Other devices | = | Error message |

Error message:

| | | |
|-----|---|--------------------------------------|
| ON | = | State error, system not operational |
| OFF | = | State OK, system ready for operation |

* This behaviour can be changed, see CANopen-Spec

TAPE YELLOW

| | | |
|-----|---|---------------------------|
| | → | Indicator for magnet tape |
| ON | = | Magnet tape missing |
| OFF | = | Magnet tape available |

9.2 CAN Interface

The standardized encoder profile CiA 406 and lift profile CiA 417 are available for LIMAX2M NEO. The factory configuration can be found in the separate document D-106013, LIMAX2M CANopen specification. The document is available for download in the customer area.

9.2.1 Pin Assignment CAN

Table 1: Pin Assignment option M12M

| 5-pin M12 connector | Function |
|---------------------|----------|
| 1 | CAN-GND |
| 2 | +24 VDC |
| 3 | 0V / GND |
| 4 | CAN_H |
| 5 | CAN_L |
| Housing | Shield |

*) please connect shield only at control unit side!



Tabelle 1: Pin Assignment option RJ45

| 8-pin RJ45 socket | Function |
|-------------------|----------|
| 1 | CAN_H |
| 2 | CAN_L |
| 3 | CAN-GND |
| 4 | N.C. |
| 5 | N.C. |
| 6 | N.C. |
| 7 | 0V / GND |
| 8 | +24 VDC |
| Housing | Shield |

*) please connect shield only at control unit side!

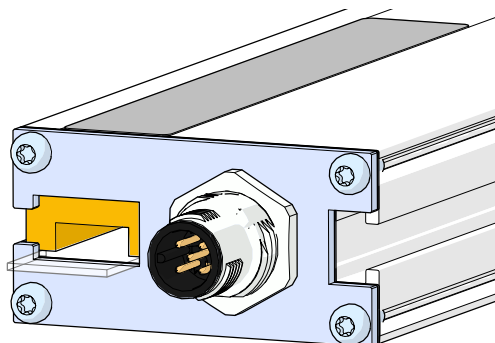
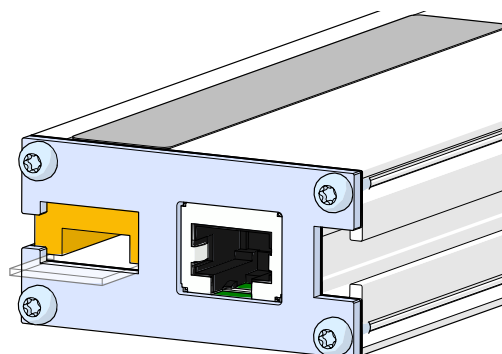

9.2.2 Command Descriptions

9.2.2.1 Initial Operation

After starting the CANopen device is in the Pre-operational Mode (☞ 9.2.4.2) and therefore doesn't send any position data. In order to achieve this, the device needs to be set into Operational Mode (☞ 9.2.4.1) and if necessary the sending cycle of the position data has to be adjusted (☞ 9.2.2.4).

9.2.2.2 Normal Mode



Note!

The commands which are described in section 9.2.2.2 Normal Mode are only processed by the CANopen device in the Operational and Pre-Operational mode.

9.2.2.3 Setting the Heartbeat Cycle Duration

A CANopen device sends the heartbeat cyclically. This message communicates the current Operating Mode to the other bus sharing units.

1. Change into the Operational or Pre-operational Mode, if necessary

- The following illustration shows the CAN-message, which should be transmitted to the CANopen device and the following answer.

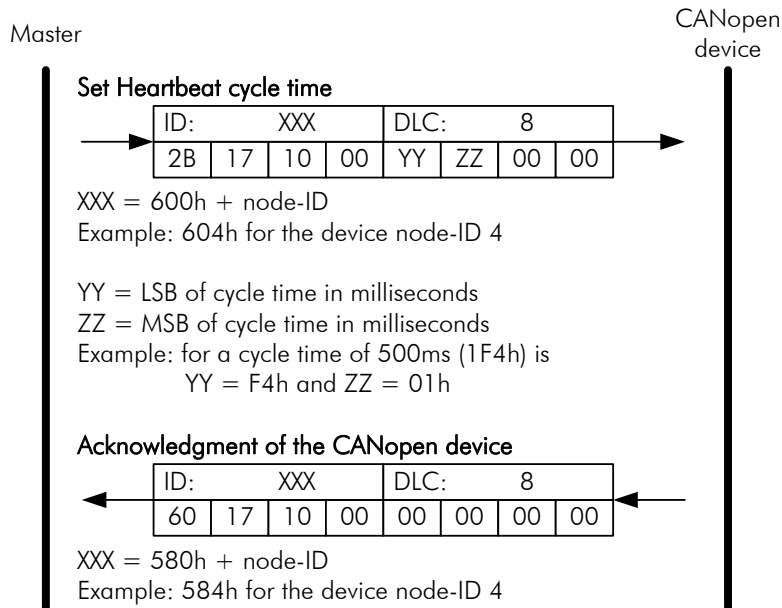

Figure 12: Setting the Heartbeat Cycle Duration

- If the setting should be maintained in the case of a power failure, the changes have to be saved, as described in section 9.2.3.

9.2.2.4 Setting the Sending Cycle for the position data

The position data are sent cyclically by the device, therefore the device has to be in the Operational Mode (9.2.4.1)

The settings of the cycle duration takes place in the device profile DS406 in the object 1800h, Sub-index 5 and for devices with DS417 profile in object 1906h, Sub-index 5.

- Change into the Operational or Pre-operational Mode, if necessary.
- The following figure shows the CAN-message, which should be transmitted to the CANopen device and the following answer.

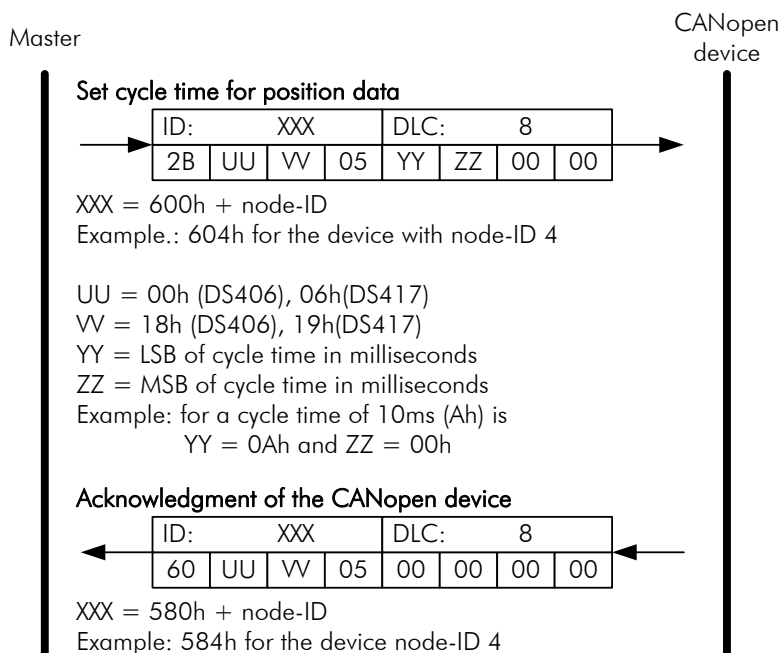

Figure 13: Setting the Sending Cycle for the position data

3. If the settings should be maintained in case of a power failure, the changes have to be saved, as described in section 9.2.3.

9.2.3 Saving the Parameters

In the normal case the settings are lost at power failure. In order to avoid this, they need to be saved according to the following procedure.

1. Change into the Operational or Pre-operational Mode, if necessary.
2. The following figure shows the CAN-message, which should be transmitted to the CANopen device and the following answer.

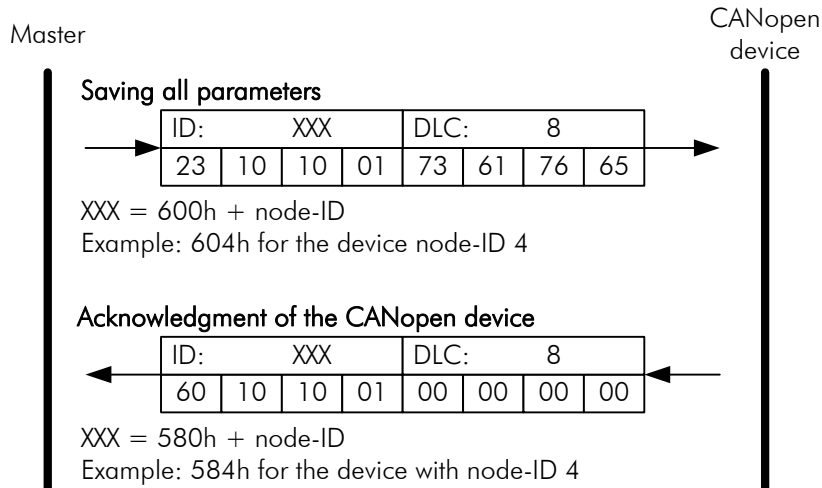

Figure 14: Saving the parameters

9.2.4 Changing the Operating Modes

9.2.4.1 Changing the device into the Operational Mode

In the Operational Mode the communication of the device is fully functional.

The following CAN-message causes the change of all CANopen participants into the Operational Mode.

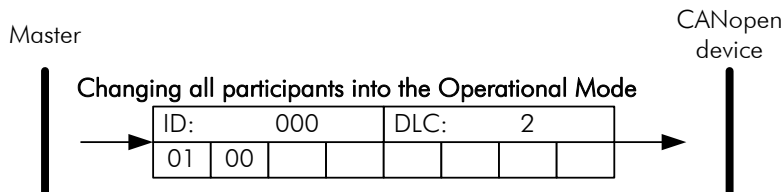

Figure 15: Changing the device into the Operational Mode

9.2.4.2 Changing the device into the Pre-operational Mode

In the Pre-operational Mode the communicating settings of the device are adjusted.

The following CAN-message causes the change of all CANopen participants into the Pre-Operational mode.

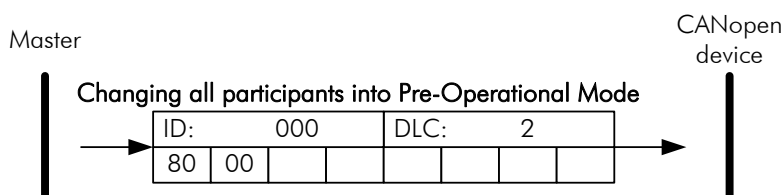

Figure 16: Changing the device into the Pre-operational Mode

9.2.4.3 Changing the device into the Stopped Mode

Bus sharing units in the Stopped Mode are passive participants. In this mode all the communication is turned off, except the monitoring activity (e.g. heartbeat).

The following CAN-message causes the change of all CANopen participants into the Stopped Mode.

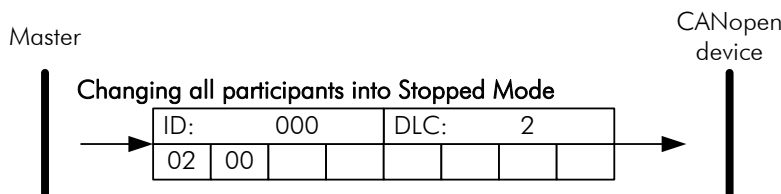



Figure 17: Changing the device into the Stopped Mode

9.2.5 LSS Configuration

Basic settings like node-ID and baud rate have to be adjusted with the Layer Setting Services (LSS).

9.2.5.1 Changing into the LSS Configuration Mode

In order to be able to change the Parameter (node-ID, bit rate), the device has to be changed into the LSS Configuration Mode.

| | |
|---|--|
|  | <p>ATTENTION!</p> <p>With the following command all the bus sharing units which are in the Stopped Mode are changed into the LSS Configuration Mode. Use this command, if only one device is connected to the bus, because other devices could be affected in their function.</p> |
|---|--|

The following CAN-message causes the change into the LSS Configuration Mode.

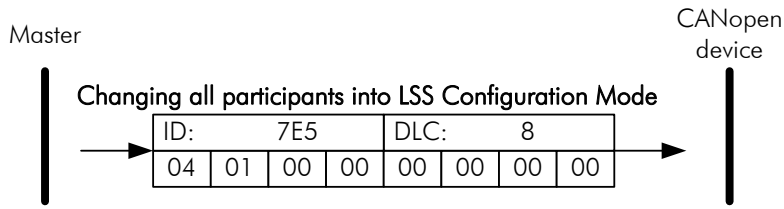

Figure 18: Changing into the LSS Configuration Mode

9.2.5.2 Saving the parameters in the LSS Mode

In order not to lose the changes in case of a power failure, they have to be saved in the non-volatile memory of the CANopen device.

The following figure shows the necessary message for this procedure.

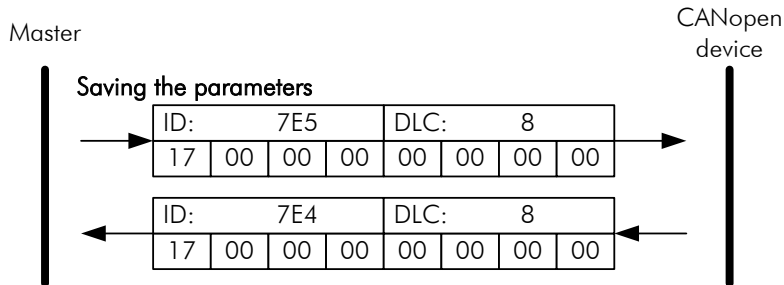



Figure 19: Saving the parameters in the LSS Mode

| | |
|---|--|
|  | <p>ATTENTION! During the saving procedure the device is not accessible over a period of a few milliseconds.</p> |
|---|--|

9.2.6 Setting the Baud rate

1. Change the device into the Stopped mode (see section 9.2.4.3)
2. Change the device into the LSS Configuration Mode (see section 9.2.5.1)
3. Change baud rate according to the following command:

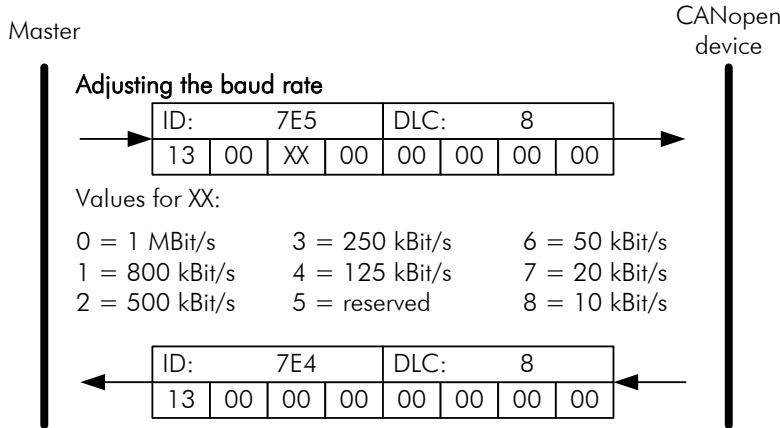

Figure 20: Setting the Baud rate

4. Save parameter as described in section 9.2.5.2.
5. Turn the device off and restart it again.

9.2.7 Setting the node-ID

1. Change the device into the Stopped Mode (see section 9.2.4.3)
2. Change the device into the LSS Configuration Mode (see section 9.2.5.1)
3. Change node-ID with the following message:

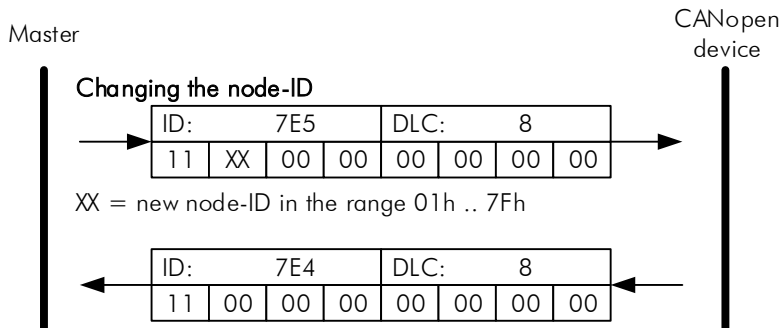

Figure 21: Setting the node-ID

4. Save parameter as described in section 9.2.5.2.
5. Turn the device off and restart it again.

9.3 SSI Interface

9.3.1 Function Principle

If the clock is not interrupted for the time $T_m - T/2$ (output of further 25 periods), the shift register clocks once again the same data value (error recognition in the evaluation). Some encoders contain a Power Failure Bit (PFB). Attention: With the LIMAX2M NEO the PFB is always "LOW"!

9.3.2 Data Protocol

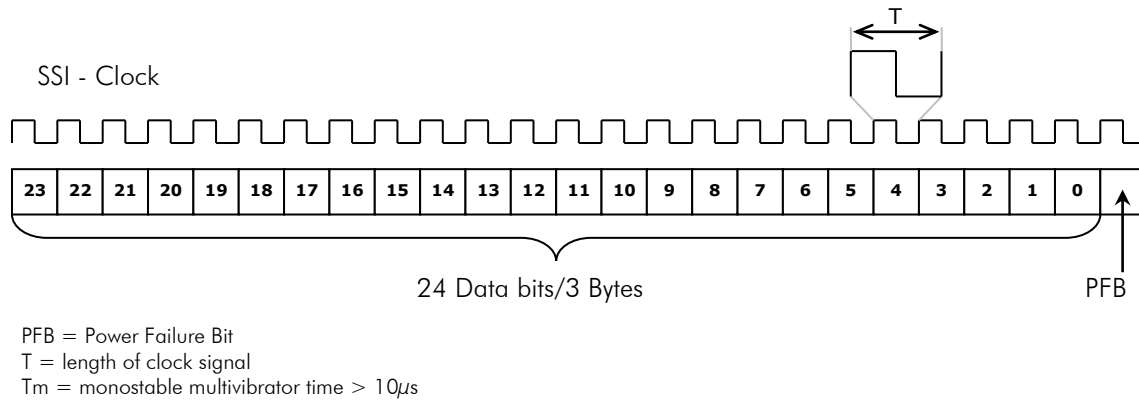

Figure 22: Data Protocol SSI

9.3.3 Pin Assignment SSI

Table 2: Pin Assignment option RJ45

| 8-pin RJ45 socket | Function |
|-------------------|----------|
| 1 | DAT- |
| 2 | DAT+ |
| 3 | GND |
| 4 | CLK- |
| 5 | CLK+ |
| 6 | VCC |
| 7 | GND |
| 8 | VCC |

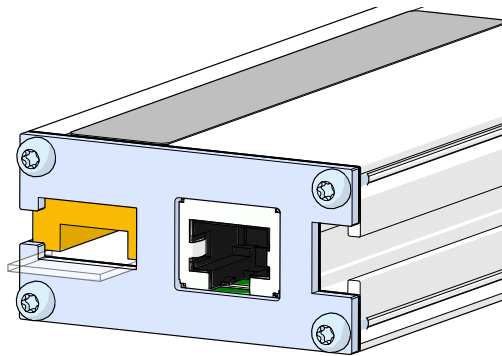
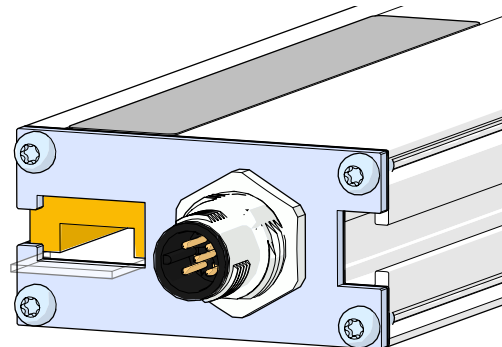

Table 3: Pin Assignment option M12M

| 8-pin M12 connector | Function |
|---------------------|----------|
| 1 | GND |
| 2 | VCC |
| 3 | CLK+ |
| 4 | CLK- |
| 5 | DAT+ |
| 6 | DAT- |
| 7 | N.C. |
| 8 | N.C. |



10 Accessories

| Order Designation | Description |
|---------------------------|---|
| AB20-80-10-1-R-D-15-BK80 | Magnetic tape for series LIMAX2M NEO |
| Guidance LIMAX2M complete | Set with guide rail with underlay and holding plate with screw |
| LIMAX RMS | Installation kit <ul style="list-style-type: none"> For centrally guided lift cars |
| LIMAX RMS 90 | Installation kit <ul style="list-style-type: none"> Angled for cabins with rucksack layout |
| LIMAX S-RMS | Installation kit <ul style="list-style-type: none"> With safety position switch |

10.1.1 Mounting Angle

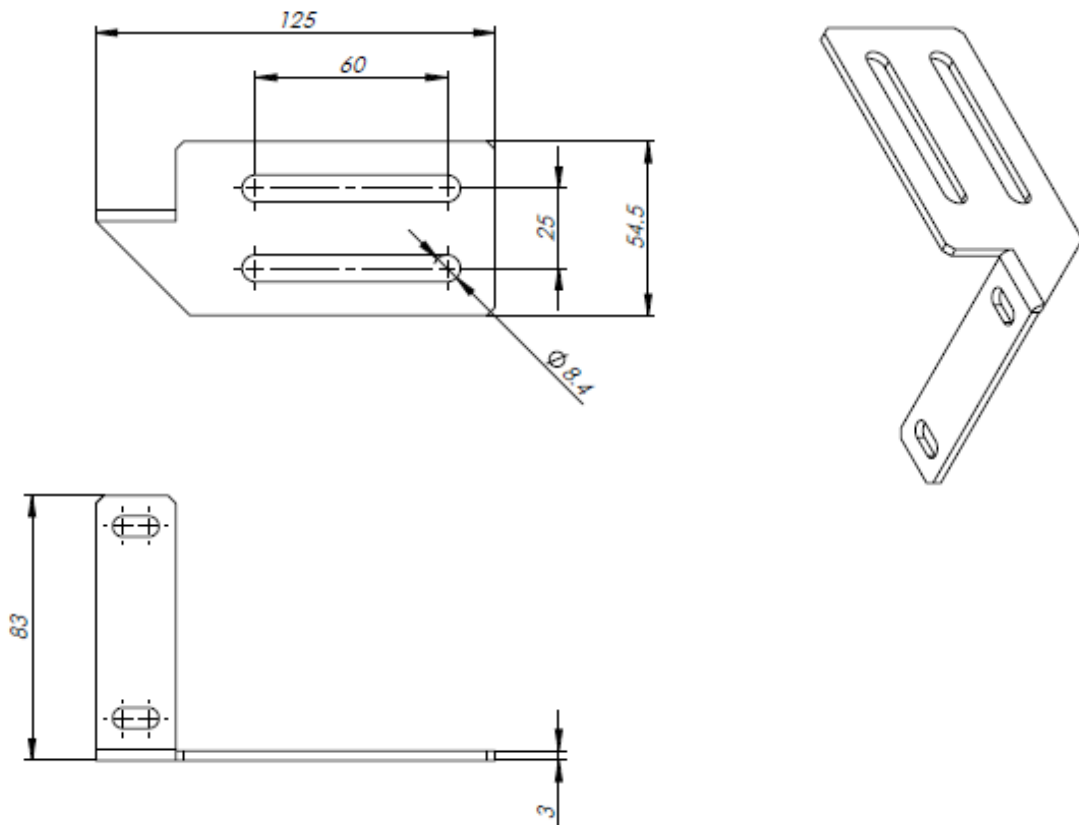

Figure 23: Mounting angle

| Order Designation | Description |
|-------------------|------------------------------|
| LIMAX2M-MW | Mounting angle for LIMAX02-M |

11 Disturbances

This chapter describes possible causes for disturbances and measures for their removal. In case of increased disturbances, please follow the measures for fault clearance in chapter 11.1.

In case of disturbances that cannot be eliminated by following the advice and the fault clearance measures given here, please contact the manufacturer (see second page).

11.1 Fault Clearance



CAUTION!

The device, the connection line and the signal cable must not be installed next to sources of interference that emit strong inductive or capacitive interference or strong electrostatic fields.

External perturbations can be avoided through suitable cable routing.



The shield of the signal output cable should only be connected to the following circuit on one side. The shield should not be grounded on both sides. Signal cables always have to be routed separately from the load power line. A safety distance of at least 0.5 m has to be kept from inductive and capacitive sources of interference such as contactors, relays, motors, switching power supplies, clocked controllers etc.!

If interferences occur in spite of all the items stated above being observed, please proceed as follows:

1. Installation of RC-circuits via contactor coils of AC-contactors (e.g. 0,1 μ F / 100 Ω)
2. Installation of recovery diodes via DC-inductors
3. Installation of RC-circuits via the different motor phases (in the terminal box of the motor)
4. Do not connect protective earth and ground
5. Connect a mains filter ahead of the external power pack

11.2 Re-start after Fault Clearance

After the fault clearance:

1. Reset the emergency stop mechanism if necessary
2. Reset the error report at the super-ordinate system if necessary.
3. Ensure that there are no persons in the danger area.
4. Follow the instructions from chapter 8.



WARNING!

Danger of injury through non-conventional fault clearance!

Non-conventional fault clearance can lead to severe injuries and damage of property.

Therefore:

- Any work to clear the faults may only be performed by sufficiently qualified staff
- Arrange enough space before starting the works
- Make sure that the mounting area is clean and tidy. Loose components and tools are sources of accidents.

If components need to be replaced:

- Pay attention to a correct installation of the spare parts.
- Reinstall all the fixing elements properly
- Before turning on the device, ensure that all covers and safety equipment is installed correctly and works properly

12 Maintenance

The device is maintenance-free.

**WARNING!**

Danger through non-conventional maintenance!

Non-conventional maintenance can lead to severe injuries and damage of property.

Therefore:

Maintenance works may only be completed by staff that has been authorized and trained by the operator.

13 Cleaning

**WARNING!**

The device can only be cleaned with a damp cloth, do not use aggressive cleanser!



Notes:

Notes:

14 Index

| | | | |
|--------------------------------------|--------|----------------------------------|--------|
| Abbreviations | 5 | Technical data | 15 |
| Accessories | 33 | Maintenance..... | 36 |
| Accident prevention regulations..... | 5 | Operating area | 17 |
| CAN Interface and Protocols..... | 26 | Operational safety..... | 5 |
| Causes of risk..... | 8 | Order reference | 12 |
| Changing the Operating Modes | 29 | Packaging material..... | 10 |
| Cleaning..... | 36 | Product features | 11 |
| Connections | 25 | Protection against contact | 17 |
| Conventional use..... | 9 | Protective equipment | 8 |
| Demounting | 7 | Safety | 5, 8 |
| Device number | 12 | Safety instructions | 5 |
| Dimensions | 13 | Safety rules | 5 |
| Disposal..... | 7 | Sensor | |
| Disturbances | 34 | Technical data | 14 |
| Explanation of symbols..... | 6 | Sensor construction | 11 |
| Fault clearance..... | 34, 35 | SSI Interface..... | 32 |
| First start-up | 17 | Start-up | 17 |
| Identification | 12 | Statement of warranties..... | 6 |
| Installation | 17 | Storage | 10 |
| Installation of the Sensor | 19 | Terms..... | 5 |
| Interfaces | 25 | Transport..... | 10 |
| LED status notice | 25 | Transport damage..... | 10 |
| Magnetic tape | | Type designation | 12, 16 |
| Structure..... | 15 | | |

Document- No.: D-108108 / Rev. 1
Document- Name : D-108108_35-23
Subject to change - © 2023
ELGO Batscale AG

ELGO Batscale AG
Measuring | Positioning | Control
Föhrenweg 20, FL-9496 Balzers
Fon.: +423 (0) 380 02 22, Fax.: +423 (0) 380 02 24
Internet: www.elgo.li, Mail: info@elgo.li

